





Quick Installation Guide

Wireless 4G LTE Router

Images may differ from actual products.

©2022 MERCUSYS 7107500242 REV1.0.0

LED Indicators

LED	Status	Indication
	Blinking Green	The router is starting up, upgrading firmware, or establishing WPS connection.
	Solid Green	The router is working properly.
	Solid Orange	Wi-Fi is off.
	Off	Power is off.
  	On	Indicates the signal strength received from the mobile internet network. More lit bars indicates a better signal strength.
	Off	There is no mobile internet signal.

1. Connect the Hardware

a. Insert the Nano SIM card into the slot until you hear a click.

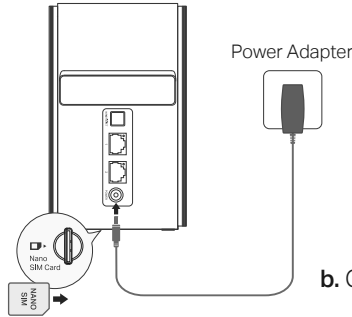

b. Connect the power adapter to the router.

2. Check the LED

Wait until the  LED turns on. Your router is connected to the internet successfully.

Note: If the LED does not turn on (no internet), refer to [FAQ-Q2](#).

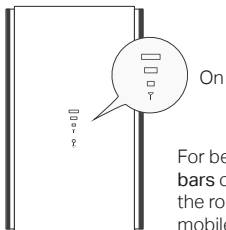

For better internet connection, make sure **2 or 3 bars** of the LED are lit. Otherwise, try relocating the router to a spot that may receive a stronger mobile network signal, such as near a window.

3. Enjoy the Internet

- **Wired**

Connect your computer to the router's LAN port via an Ethernet cable.

- **Wireless**

a. Find the default SSID (network name) and wireless password printed on the label at the bottom of the router.



b. Click the network icon of your computer or go to Wi-Fi settings of your smart device, and then select the SSID to join the network.

Customize the 4G LTE Router

If you want to customize router settings, follow the steps below.

1. Make sure your computer is connected to the router (wired or wireless).
2. Launch a web browser and type in <http://mwlogin.net>. Create a password for future logins.
Note: If the login page does not appear, please refer to [FAQ-Q1](#).
3. Follow the step-by-step instructions of the Quick Setup to complete the initial configuration.

Note: The router can also be used (or configured) in Wireless Router Mode for DSL/Cable/Fiber connections. For more advanced configurations, please refer to the user guide at <https://www.mercusys.com/support/>.

FAQ (Frequently Asked Questions)

Q1. What should I do if I cannot access the web management page?

- Reboot your router and try again.
- If the computer is set to a static IP address, change its settings to obtain an IP address automatically.
- Make sure <http://mwlogin.net> is correctly entered in the web browser.
- Use another web browser and try again.
- Disable and enable the active network adapter in use.

Q2. What should I do if I cannot access the internet?

- Verify that your SIM card is an LTE or WCDMA card.
- Verify that your SIM card is in your internet service provider's service area.
- Verify that your SIM card has sufficient credit.
- Log in to the router's web management page, and check the following:
 - 1) Go to **Advanced > Network > PIN Management** to verify if PIN is required. If it is, enter the correct PIN provided by your ISP.
 - 2) Go to **Advanced > Network > Internet** to verify the parameters provided by your ISP are correctly entered. If they are incorrect, click **Create Profile** and enter the correct parameters, then select the new profile from the **Profile Name** list.
 - 3) Go to **Advanced > Network > Data Settings** to verify if the used data exceeds the allowance. If it does, click **Correct** and set the used data to 0 (zero), or disable **Data Limit**.
 - 4) Go to **Advanced > Network > Internet** to verify that **Mobile Data** is enabled. If it is not, enable it to access the internet.
 - 5) Confirm with your ISP if you are in a roaming service area. If you are, go to **Advanced > Network > Internet** to enable **Data Roaming**.

Install External Antennas*

If you have external antennas, you can install them to strengthen the LTE Network.

1. Open the back cover.
2. Connect your external antennas.
3. Log in to the web page (<http://mwlogin.net>), then go to **Advanced > Wireless > Antenna Settings** to select external antennas.

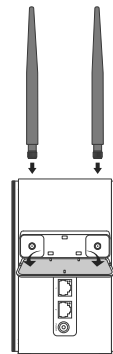

* External antennas not provided.



Q3. How do I restore the router to its factory default settings?

- With the router powered on, press and hold the **WPS/RESET** button on the rear panel until the **⏻** LED starts blinking, then release the button. Wait until the router reboots.
- Log in to the router's web management page, go to **Advanced > System Tools > Backup & Restore**, and click **Factory Restore**. Wait until the reset process is complete.

Q4. What should I do if I forget my wireless network password?

- The default wireless password is printed on the product label of the router.
- Connect a computer directly to the router via an Ethernet cable. Log in to the router's web management page and go to **Basic > Wireless** to retrieve or reset your wireless password.

Safety Information

- Keep the device away from water, fire, humidity or hot environments.
- Do not attempt to disassemble, repair, or modify the device. If you need service, please contact us
- Do not use damaged charger or USB cable to charge the device.
- Do not use any other chargers than those recommended.
- Do not use the device where wireless devices are not allowed.
- Adapter shall be installed near the equipment and shall be easily accessible.

MERCUSYS hereby declares that the device is in compliance with the essential requirements and other relevant provisions of directives 2014/53/EU, 2009/125/EC, 2011/65/EU and (EU)2015/863.

The original EU Declaration of Conformity may be found at <https://www.mercusys.com/en/ce>

MERCUSYS hereby declares that the device is in compliance with the essential requirements and other relevant provisions of the Radio Equipment Regulations 2017.

The original UK Declaration of Conformity may be found at <https://www.mercusys.com/support/ukca/>



For technical support, replacement services, user guides, and other information, please visit <https://www.mercusys.com/support/>.