



Ruijie RG-S5750H Series Switches

Hardware Installation and Reference Guide, V1.D

Copyright Statement

Ruijie Networks©2020

Ruijie Networks reserves all copyrights of this document. Any reproduction, excerption, backup, modification, transmission, translation or commercial use of this document or any portion of this document, in any form or by any means, without the prior written consent of Ruijie Networks is prohibited.

Exemption Statement

This document is provided "as is". The contents of this document are subject to change without any notice. Please obtain the latest information through the Ruijie Networks website. Ruijie Networks endeavors to ensure content accuracy and will not shoulder any responsibility for losses and damages caused due to content omissions, inaccuracies or errors.

Preface

Thank you for using our products. This manual will guide you through the installation of the device.

This manual describes the functional and physical features and provides the device installation steps, hardware troubleshooting, module technical specifications, and specifications and usage guidelines for cables and connectors.

Audience

It is intended for the users who have some experience in installing and maintaining network hardware. At the same time, it is assumed that the users are already familiar with the related terms and concepts.

Obtaining Technical Assistance

- Ruijie Networks Website: <https://www.ruijienetworks.com/>
- Technical Support Website: <https://ruijienetworks.com/support>
- Case Portal: <http://caseportal.ruijienetworks.com>
- Community: <http://community.ruijienetworks.com>
- Technical Support Email: service_rj@ruijienetworks.com
- Skype: [service_rj@ruijienetworks.com](https://www.skype.com/people/service_rj@ruijienetworks.com)

Related Documents

Documents	Description
Configuration Guide	Describes network protocols and related mechanisms that supported by the product, with configuration examples.
Command Reference	Describes the related configuration commands, including command modes, parameter descriptions, usage guides, and related examples.

Symbol Conventions

 Means reader take note. Notes contain helpful suggestions or references.

 Means reader be careful. In this situation, you might do something that could result in equipment damage or loss of data.

1 Product Overview

Ruijie RG-S5750H series switches are the next-generation Layer 3 switches. Featuring high performance, reliable security, and multiple services, RG-S5750H series switches are mainly applicable to the convergence layer of large-scale networks to provide full line-rate exchanging. Complete QoS features differentiate services according to business needs to ensure the prompt transmission of key data. The RG-S5750H series switches provide various interfaces to meet the requirement for interfaces in network constructions.

RG-S5750H Series Switches

Model	10/100/1000 Base-T Ethernet Port	1000M SFP Port	10G SFP+ Port	MGMT Port	USB Port	Mini USB Port	Console Port	Expansion Module Slot	RPS
RG-S5750C-28GT4XS-H	28	4 (4 Combo)	4	1	1	1	1	2	Dual
RG-S5750C-48GT4XS-H	48	N/A	4	1	1	1	1	2	Dual
RG-S5750C-28SF P4XS-H	8	28 (8 combo)	4	1	1	1	1	2	Dual
RG-S5750C-48SF P4XS-H	N/A	48	4	1	1	1	1	2	Dual
RG-S5750-48GT4XS-HP-H	48	N/A	4	1	1	1	1	N/A	Dual
RG-S5750-24GT4XS-HP-H	24	N/A	4	1	1	N/A	1	N/A	Dual

i Combo port consists of one 1000Base-X SFP port and one 10/100/1000Base-T Ethernet port. That is, only one port of them is available at a particular time.

i SFP+ port supports both 10Gbase-R and 1000base-X.

i RG-S5750-24GT4XS-HP-H will be delivered with two RG-M5000E-AC500P modules by default.

RG-S5750H series switches have the following external ports:

- **MGMT port:** This port is a 10/100/1000M management port. It is used to connect with an Ethernet port of a PC to perform program. It also supports Data Center Manageability Interface (DCMI) protocol, and users can do remote management and maintenance for the switch through the port. Use standard network cables when the port is connected with an Ethernet port.

- USB port: The Universal Serial Bus (USB) port is used to connect with USB memory to save logs, host versions, warnings and other diagnostic messages.
- Console port: This port applies RS-232 interface electrical level and standard RJ45 connectors. It is used to connect the serial ports of the terminal PC to perform tasks including system commissioning, configuration, maintenance, management, and software loading.
- Mini USB port: This port can be used as a serial port for installing the software driver. For detail, see *Appendix F*.

 The RG-S5750H series supports both Console and Mini USB ports to conduct commissioning, configuration, maintenance, management, and software loading. However, these functions are activated on only one of them at a particular time.

- RG-S5750H series switch is a class A product. In a domestic environment, this product may cause radio interference in which case the user may be required to take adequate measures.
- Warning: Disconnect the power source prior to open case, and close case before restoring power.
- Warning: Hazardous moving parts. Keep away from moving fan blades.
- For DC input: Reinforce insulation or double insulation must be provided to isolate DC source from the AC mains supply.
- For DC input: A readily accessible disconnect device shall be incorporated in the building installation wiring.
- For AC input: the socket-outlet shall be installed near the equipment and shall be easily accessible.
- Because the device has several power supplies, disconnect all of them to switch off the device.
- When installing the unit, always make the ground connection first and disconnect it last.
- The device must be connected permanently to the protection ground before an operation. The cross sectional area of protective ground conductor shall be at least 0.75 mm².

1.1 RG-S5750C-28GT4XS-H

Technical Specifications

Model	RG-S5750C-28GT4XS-H
CPU	Dual-core with each 1.0 GHz
BOOTROM	8 MB
Flash Memory	512 MB
SDRAM	1 GB
Optical Module	See <i>Appendix B</i> .  The supported module type may change at any time. Consult Ruijie Networks for the latest information.
Expansion Module Slot	<ul style="list-style-type: none"> ● 2 slots ● Supported expansion module: M5000H-01QXS (for stack), M5000H-MSA (multiple service cards)
Power Module Slot	<ul style="list-style-type: none"> ● 2 slots

	<ul style="list-style-type: none"> ● Supported power module: RG-PA70I ● AC input: Rated voltage: 100V to 240V Maximum voltage: 90V to 264V Frequency: 50/60 Hz Rated current per input: 2A ● HVDC input: Rated voltage: 120V to 340V Maximum voltage: 110V to 380V Rated current per input: 2A ● Supported power module: RG-PD70I DC input: Rated voltage: -36V to -72V Rated current per input: 3.15A
SFP Port	1000Base-X 100Base-X
SFP+ Port	10GBase-R 1000Base-X
Power Consumption	<45W (without expansion modules)
Temperature	Operating temperature: 0 °C to 50°C Storage temperature: -40 °C to 70°C
Humidity	Operating humidity: 10% to 90% RH Storage humidity: 5% to 95% RH
Altitude	0 to 5000m
Fan	Speed adjustment and fault alarm
Temperature Alarm	Supported
EMI Standard	GB9254-2008CLASS A
Safety Standard	GB4943-2011
Dimensions (W x D x H)	440 mm x 280 mm x 44 mm
Weight	3.9 kg

Product Appearance

The RG-S5750C-28GT4XS-H Ethernet switch provides 28 10/100/1000Base-T Ethernet ports, 4 GE SFP combo ports, 4 10GE SFP+ ports, 1 MGMT port, 1 USB port, 1 Mini USB port, and 1 Console port on the front panel, as well as 2 power module slots and 2 expansion module slots on the back panel (The Console and Mini USB ports are a combo Console port. When they are connected meanwhile, the Mini USB port takes the precedence).

Figure 1-1 Appearance of RG-S5750C-28GT4XS-H

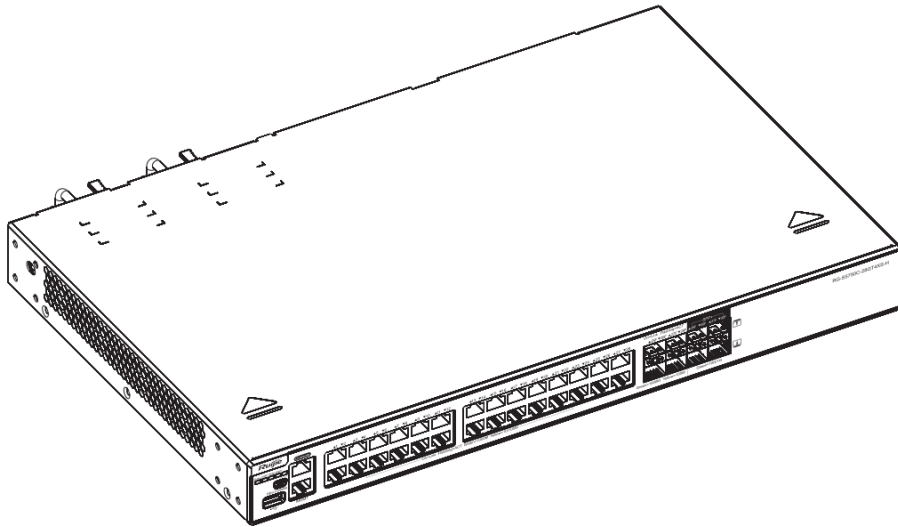

Front Panel

Figure 1-2 Front Panel of RG-S5750C-28GT4XS-H

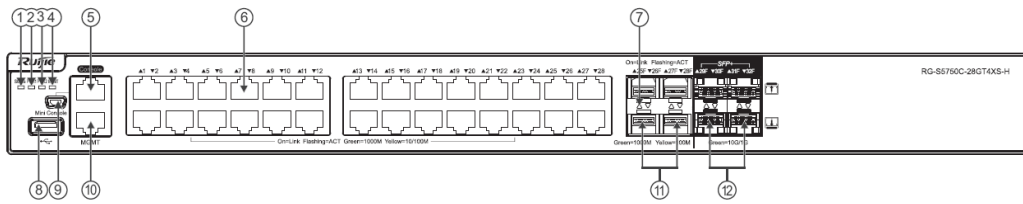

<p>Note:</p>	<ol style="list-style-type: none"> 1. System status LED 2. Power status LED (PWR1) 3. Power status LED (PWR2) 4. MGMT port status LED 5. Console port 6. 10/100/1000 Base-T Ethernet port 	<ol style="list-style-type: none"> 7. Switch port status LED 8. USB port 9. Mini USB port 10. MGMT port 11. GE SFP port 12. 10GE SFP+ port
--------------	---	--

Back Panel

Figure 1-3 Back Panel of RG-S5750C-28GT4XS-H

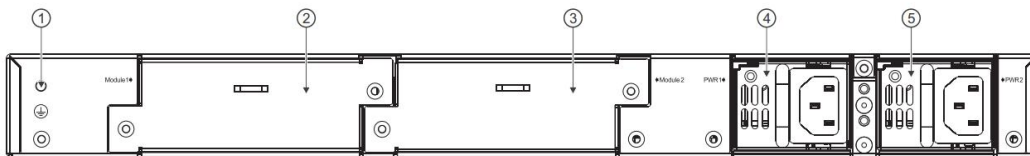

<p>Note:</p>	<ol style="list-style-type: none"> 1. Grounding connector 2. Expansion module slot 1 3. Expansion module slot 2 	<ol style="list-style-type: none"> 4. Power module slot 1 5. Power module slot 2
--------------	--	--

Power Supply

RG-S5750C-28GT4XS-H supports 2 power modules. For details, see the section “Power Modules”.

Dual-power input: The switch can be powered by one power module, or two power modules. When both two modules are available, the switch is powered in current sharing mode.

⚠ When the switch is powered by the dual-power modules, if the system working power is greater than the capacity of single power module, power redundancy cannot work; if one power module fails, the switch system will be affected.

Heat Dissipation

The RG-S5750C-28GT4XS-H is designed with left and right fans for heat dissipation, thereby ensuring the normal function of the device in the specified environment. Maintain a minimum clearance of 10cm around the chassis to allow air circulation.

Figure 1-4 Flow Scheme of Heat Dissipation

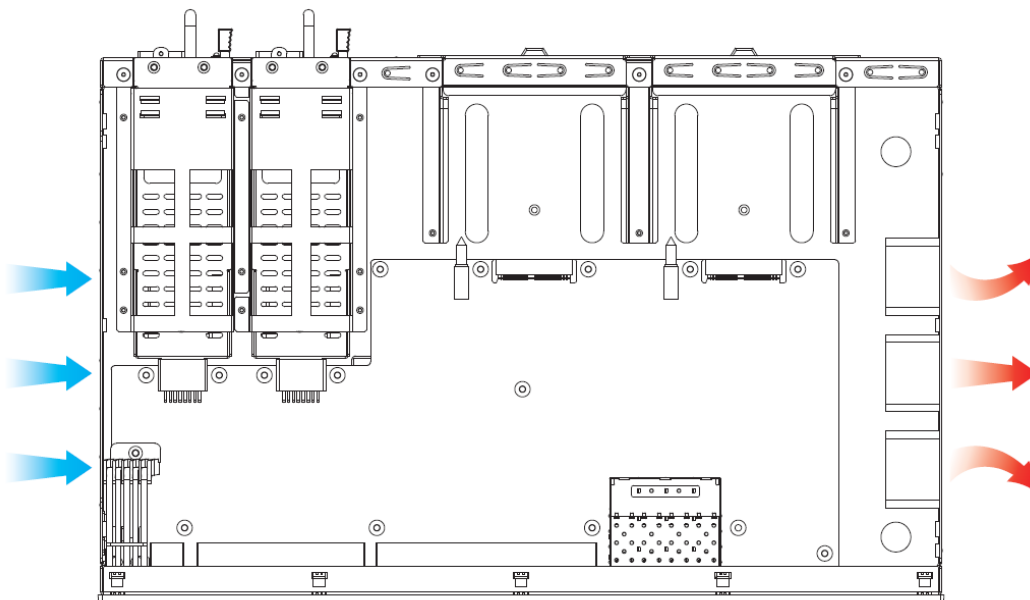

LED

LED	Panel Identification	State	Meaning
System status LED	Status	Off	The switch is not receiving power.
		Blinking green (3 Hz)	The switch is being initialized with 3Hz blinking. Continuous blinking indicates errors.
		Blinking green (10Hz)	Supports remote on/off to locate the switch.
		Solid green	The switch is operational.
		Solid yellow	Temperature alarm: 1. Temperature of inlet/outlet air exceeds the normal operating temperature range. 2. The power supplies cannot support the whole system. Check the working environment of the switch and

LED	Panel Identification	State	Meaning
			power supplies immediately.
		Solid red	The switch is faulty. For details, see the chapter “Troubleshooting”.
Power status LED	PWR1/PWR2	Off	The power module is not in place or not receiving power.
		Solid green	The power module is connected and can supply power.
		Solid yellow	The power model is identified but not recognized.
		Solid red	The redundant power is faulty or the AC power cord is not connected.
MGMT port status LED	MGMT	Off	The port is not connected.
		Solid green	The port is connected at 1000 Mbps.
		Blinking green	The port is receiving or transmitting traffic at 1000 Mbps.
		Solid yellow	The port is connected at 10/100 Mbps.
		Blinking yellow	The port is receiving or transmitting traffic at 10/100 Mbps.
10GE SFP+ port status LED	29F-32F	Off	The port is not connected.
		Solid green	The port is connected at 1/10 Gbps.
		Blinking green	The port is receiving or transmitting traffic at 1/10 Gbps.
GE SFP port status LED	25F-28F	Off	The port is not connected.
		Solid green	The port is connected at 1000 Mbps.
		Blinking green	The port is receiving or transmitting traffic at 1000 Mbps.
		Solid yellow	The port is connected at 100 Mbps.
		Blinking yellow	The port is receiving or transmitting traffic at 100 Mbps.
10/100/1000Base-T Ethernet port status LED	1-28	Off	The port is not connected.
		Solid green	The port is connected at 1000 Mbps.
		Blinking green	The port is receiving or transmitting traffic at 1000 Mbps.
		Solid yellow	The port is connected at 10/100 Mbps.
		Blinking yellow	The port is receiving or transmitting traffic at 10/100 Mbps.

1.2 RG-S5750C-48GT4XS-H

Technical Specifications

Model	RG-S5750C-48GT4XS-H
CPU	Dual-core with each 1.0 GHz

BOOTROM	8 MB
Flash Memory	512 MB
SDRAM	1 GB
Optical Module	<p>See <i>Appendix B</i>.</p> <p> The supported module type may change at any time. Consult Ruijie Networks for the latest information.</p>
Expansion Module Slot	<ul style="list-style-type: none"> ● 2 slots ● Supported expansion modules: M5000H-04XS (for expansion module slot 1) M5000H-01QXS (for stack) M5000H-MSC (multiple service cards)
Power Module Slot	<ul style="list-style-type: none"> ● 2 slots ● Supported power modules: RG-PA70I ● AC input Rated voltage: 100V to 240V Maximum voltage: 90V to 264V Frequency : 50/60 Hz Rated current per input: 2A ● HVDC input Rated voltage: 120V to 340V Maximum voltage: 110V to 380V Rated current per input: 2A ● Supported power module: RG-PD70I DC input: Rated voltage: -36V to -72V Rated current per input: 3.15A
SFP Port	Not supported
SFP+ Port	10GBase-R 1000Base-X
Power Consumption	<45W (without expansion modules)
Temperature	Operating temperature: 0 °C to 50°C

	Storage temperature: -40 °C to 70°C
Humidity	Operating humidity: 10% to 90% RH Storage humidity: 5% to 95% RH
Altitude	0 to 5000m
Fan	Speed adjustment and fault alarm
Temperature Alarm	Supported
EMI Standard	GB9254-2008CLASS A
Safety Standard	GB4943-2011
Dimensions (W x D x H)	440 mm x 300 mm x 44 mm
Weight	4.2 kg

Product Appearance

The RG-S5750C-48GT4XS-H Ethernet switch provides 48 10/100/1000Base-T Ethernet ports, 4 10GE SFP+ ports, 1 MGMT port, 1 USB port, 1 Mini USB port, and 1 Console port on the front panel, as well as 2 power module slots and 2 expansion module slots on the back panel (The Console and Mini USB ports are a combo Console port. When they are connected meanwhile, the Mini USB port takes the precedence).

Figure 1-5 Appearance of RG-S5750C-48GT4XS-H

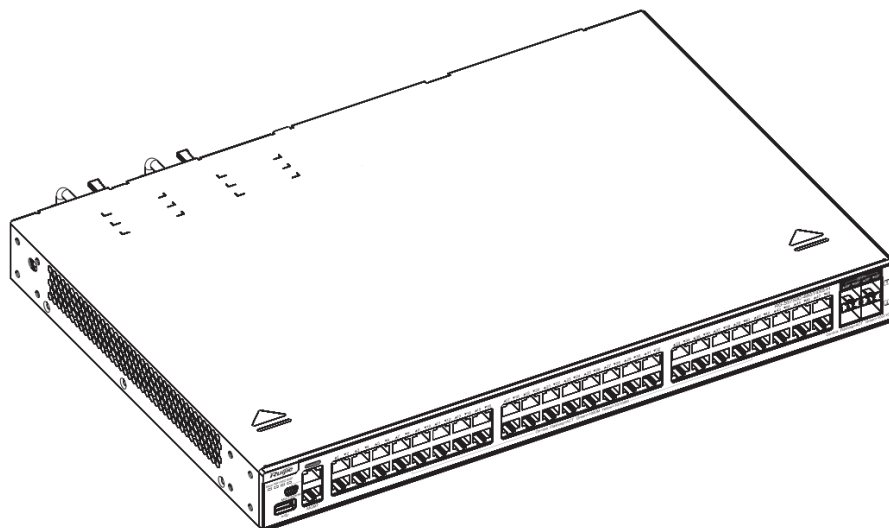

Front Panel

Figure 1-6 Front Panel of RG-S5750C-48GT4XS-H

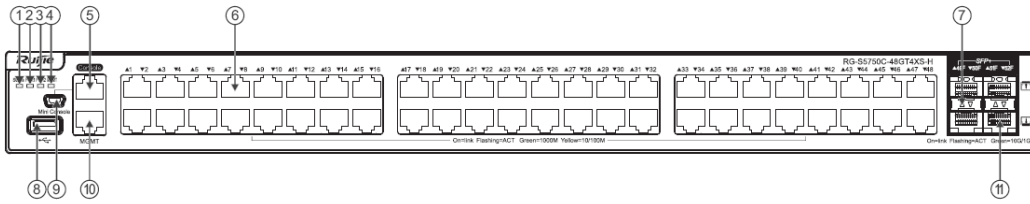

<p>Note:</p>	<ol style="list-style-type: none"> 1. System status LED 2. Power status LED (PWR1) 3. Power status LED (PWR2) 4. MGMT port status LED 5. Console port 6. 10/100/1000Base-T Ethernet port 	<ol style="list-style-type: none"> 7. Switch port status LED 8. USB port 9. Mini USB port 10. MGMT port 11. 10GE SFP+ port
--------------	--	---

Back Panel

Figure 1-7 Back Panel of RG-S5750C-48GT4XS-H

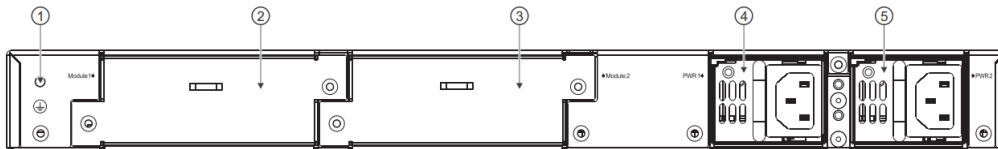

<p>Note:</p>	<ol style="list-style-type: none"> 1. Grounding connector 2. Expansion module slot 1 3. Expansion module slot 2 	<ol style="list-style-type: none"> 4. Power module slot 1 5. Power module slot 2
--------------	--	--

Power Supply

The RG-S5750C-48GT4XS-H supports two power modules. For details, see the section “Power Modules”.

Dual-power input: The switch can be powered by one power module, or two power modules. When both two modules are available, the switch is powered in current sharing mode.

! When the switch is powered by the dual-power modules, if the system working power is greater than the capacity of single power module, power redundancy cannot work; if one power module fails, the switch system will be affected.

Heat Dissipation

RG-S5750C-48GT4XS-H adopts left and right fans for heat dissipation, thereby ensuring the normal function of the device in the specified environment. Sufficient space (10 cm distance from both sides and the back panel of the cabinet) should be reserved around the cabinet to allow air circulation.

Figure 1-8 Flow Scheme of Heat Dissipation

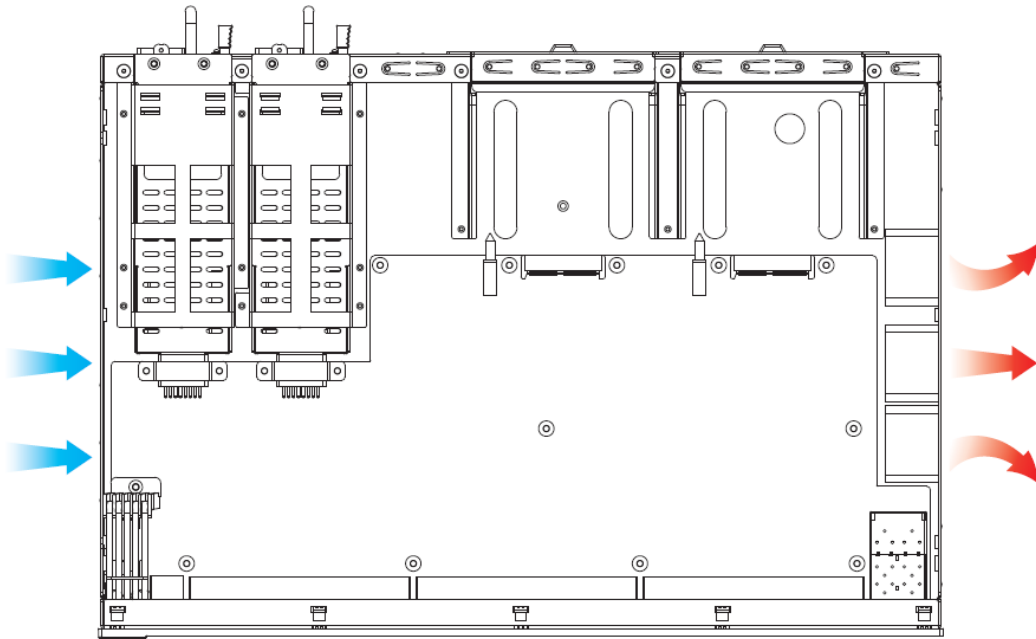

LED

LED	Panel Identification	State	Meaning
System status LED	Status	Off	The switch is not receiving power.
		Blinking green (3 Hz)	The switch is being initialized with 3Hz blinking. Continuous blinking indicates errors.
		Blinking green (10Hz)	Supports remote on/off to locate the switch.
		Solid green	The switch is operational.
		Solid yellow	Temperature alarm: 1. Temperature of inlet/outlet air exceeds the normal operating temperature range. 2. The power supplies cannot support the whole system. Check the working environment of the switch and power supplies immediately.
Solid red	The switch is faulty. For details, see the chapter "Troubleshooting".		
Power status LED	PWR1/PWR2	Off	The power module is not in place or not receiving power.
		Solid green	The power module is connected and can supply power.
		Solid red	The redundant power is faulty or the AC power cord is not connected.
MGMT port status LED	MGMT	Off	The port is not connected.
		Solid green	The port is connected at 1000 Mbps.
		Blinking green	The port is receiving or transmitting traffic at

LED	Panel Identification	State	Meaning
			1000 Mbps.
		Solid yellow	The port is connected at 10/100 Mbps.
		Blinking yellow	The port is receiving or transmitting traffic at 10/100 Mbps.
10GE SFP+ port status LED	49F-52F	Off	The port is not connected.
		Solid green	The port is connected at 1/10 Gbps.
		Blinking green	The port is receiving or transmitting traffic at 1/10 Gbps.
10/100/1000Base-T Ethernet port status LED	1-48	Off	The port is not connected.
		Solid green	The port is connected at 1000 Mbps.
		Blinking green	The port is receiving or transmitting traffic at 1000 Mbps.
		Solid yellow	The port is connected at 10/100 Mbps.
		Blinking yellow	The port is receiving or transmitting traffic at 10/100 Mbps.

1.3 RG-S5750C-28SFP4XS-H

Technical Specifications

Model	RG-S5750C-28SFP4XS-H
CPU	Dual-core with each 1.0 GHz
BOOTROM	8 MB
Flash Memory	512 MB
SDRAM	1 GB
Optical Module	<p>See <i>Appendix B</i>.</p> <p> The supported module type may change at any time. Consult the Ruijie Networks for the latest information.</p>
Expansion Module Slot	<ul style="list-style-type: none"> ● 2 slots ● Supported expansion module : M5000H-01QXS (for stack), M5000H-MSA (multiple service cards)
Power Module Slot	<ul style="list-style-type: none"> ● 2 slots ● Supported power module: RG-PA70I ● AC input: <ul style="list-style-type: none"> Rated voltage: 100V to 240V Maximum voltage: 90V to 264V Frequency: 50/60 Hz

	<p>Rated current per input: 2 A</p> <ul style="list-style-type: none"> ● HVDC input: <ul style="list-style-type: none"> Rated voltage: 120V to 340V Maximum voltage: 110V to 380V Rated current per input: 2A ● Supported power module: RG-PD70I <ul style="list-style-type: none"> DC input: <ul style="list-style-type: none"> Rated voltage: -36V to -72V Rated current per input: 3.15A
SFP Port	100Base-X 1000Base-X
SFP+ Port	10GBase-R 1000Base-X
Power Consumption	<55W (without expansion modules)
Temperature	Operating temperature: 0 °C to 50°C Storage temperature: -40°C to 70°C
Humidity	Operating humidity: 10% to 90% RH Storage humidity: 5% to 95% RH
Altitude	0 to 5000m
Fan	Speed adjustment and fault alarm
Temperature Alarm	Supported
EMI Standard	GB9254-2008CLASS A
Safety Standard	GB4943-2011
Dimensions (W x D x H)	440 mm x 300 mm x 44 mm
Weight	4.2kg

Product Appearance

The RG-S5750C-28SFP4XS-H Ethernet switch provides 28 GE SFP ports, 8 10/100/1000Base-T GE combo ports, 4 10GE SFP+ ports, 1 MGMT port, 1 USB port, 1 Mini USB port, and 1 Console port on the front panel, as well as 2 power module slots and 2 expansion module slots on the back panel.

Figure 1-9 Appearance of RG-S5750C-28SFP4XS-H

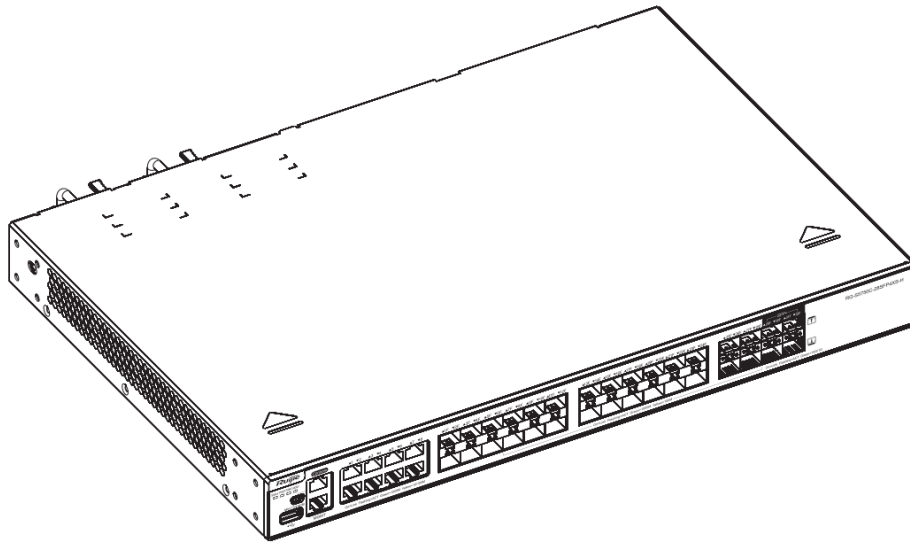

Front Panel

Figure 1-10 Front Panel of RG-S5750C-28SFP4XS-H

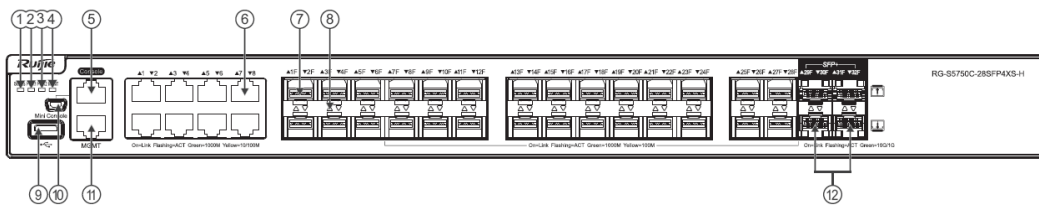

<p>Note:</p>	<ol style="list-style-type: none"> 1. System status LED 2. Power status LED (PWR1) 3. Power status LED (PWR2) 4. MGMT port status LED 5. Console port 6. 10/100/1000Base-T Ethernet port 	<ol style="list-style-type: none"> 7. GE SFP port 8. Switch port status LED 9. USB port 10. Mini USB port 11. MGMT port 12. 10GE SFP+ port
--------------	--	--

Back Panel

Figure 1-11 Back Panel of RG-S5750C-28SFP4XS-H

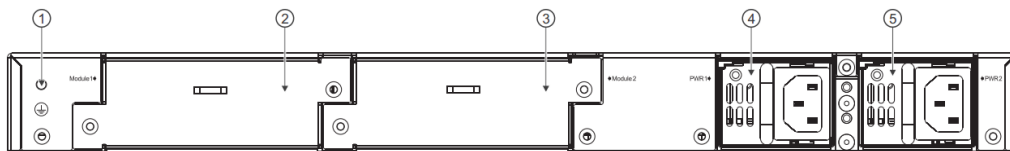

<p>Note:</p>	<ol style="list-style-type: none"> 1. Grounding connector 2. Expansion module slot 1 3. Expansion module slot 2 	<ol style="list-style-type: none"> 4. Power module slot 1 5. Power module slot 2
--------------	--	--

Power Supply

The RG-S5750C-28SFP4XS-H supports two power modules. For details, see the section “Power Modules”.

Dual-power input: The switch can be powered by one power module, or two power modules. When both two modules are available, the switch is powered in current sharing mode.

⚠ When the switch is powered by the dual-power modules, if the system working power is greater than the capacity of single power module, power redundancy cannot work; if one power module fails, the switch system will be affected.

Heat Dissipation

The RG-S5750C-28SFP4XS-H is designed with left and right fans for heat dissipation, thereby ensuring the normal function of the device in the specified environment. Sufficient space (10 cm distance from both sides and the back panel of the cabinet) should be reserved to allow air circulation.

Figure 1-12 Flow Scheme of Heat Dissipation

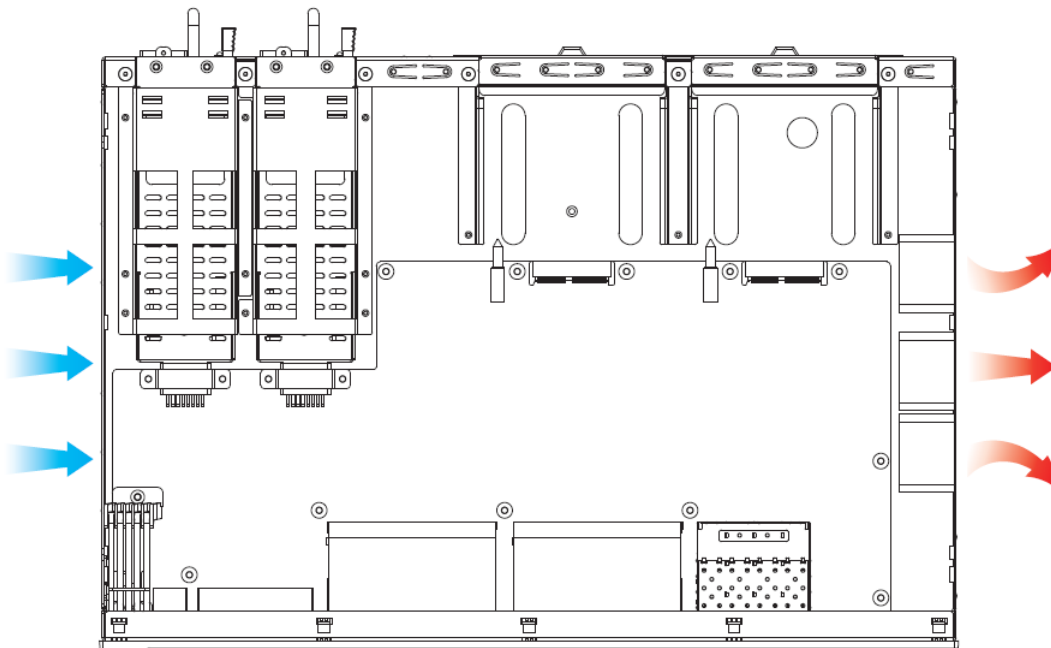

LED

LED	Panel Identification	State	Meaning
System status LED	Status	Off	The switch is not receiving power.
		Blinking green (3 Hz)	The switch is being initialized with 3Hz blinking. Continuous blinking indicates errors.
		Blinking green (10Hz)	Supports remote on/off to locate the switch.
		Solid green	The switch is operational.
		Solid yellow	Temperature alarm: 1. Temperature of inlet/outlet air exceeds the normal operating temperature range. 2. The power supplies cannot support the whole system. Check the working environment of the switch and power supplies immediately.
Solid red	The switch is faulty. For details, see the chapter		

LED	Panel Identification	State	Meaning
			"Troubleshooting".
Power status LED	PWR1/PWR2	Off	The power module is not in place or not receiving power.
		Solid green	The power module is in place and can supply power.
		Solid red	The redundant power is faulty or the AC power cord is not connected.
MGMT port status LED	MGMT	Off	The port is not connected.
		Solid green	The port is connected at 1000 Mbps.
		Blinking green	The port is receiving or transmitting traffic at 1000 Mbps.
		Solid yellow	The port is connected at 10/100 Mbps.
		Blinking yellow	The port is receiving or transmitting traffic at 10/100 Mbps.
10GE SFP+ port status LED	29F-32F	Off	The port is not connected.
		Solid green	The port is connected at 1/10 Gbps.
		Blinking green	The port is receiving or transmitting traffic at 1/10 Gbps.
GE SFP port status LED	1F-28F	Off	The port is not connected.
		Solid green	The port is connected at 1000 Mbps.
		Blinking green	The port is receiving or transmitting traffic at 1000 Mbps.
		Solid yellow	The port is connected at 100 Mbps.
		Blinking yellow	The port is receiving or transmitting traffic at 100 Mbps.
10/100/1000Base-T Ethernet port status LED	1-8	Off	The port is not connected.
		Solid green	The port is connected at 1000 Mbps.
		Blinking green	The port is receiving or transmitting traffic at 1000 Mbps.
		Solid yellow	The port is connected at 10/100 Mbps.
		Blinking yellow	The port is receiving or transmitting traffic at 10/100 Mbps.

1.4 RG-S5750C-48SFP4XS-H

Technical Specifications

Model	RG-S5750C-48SFP4XS-H
CPU	Dual-core with each 1.0 GHz
BOOTROM	8 MB
Flash Memory	512 MB

SDRAM	1 GB
Optical Module	<p>See <i>Appendix B</i>.</p> <p> The supported module type may change at any time. Consult the Ruijie Networks for the latest information.</p>
Expansion Module Slot	<ul style="list-style-type: none"> ● 2 slots ● Supported expansion module : M5000H-01QXS (for stack) and M5000H-04XS (for expansion slot 1)
Power Module Slot	<ul style="list-style-type: none"> ● 2 slots ● Supported power module: RG-PA150I-F ● AC input: <ul style="list-style-type: none"> Rated voltage: 100V to 240V Maximum voltage: 90V to 264V Frequency: 50/60 Hz Rated current per input: 3 A ● HVDC input: <ul style="list-style-type: none"> Rated voltage: 240VDC Maximum voltage: 192V to 288V Rated current per input: 3A
SFP Port	100Base-X 1000Base-X
SFP+ Port	10GBase-R 1000Base-X
Power Consumption	<100W (without expansion modules)
Temperature	Operating temperature: 0 °C to 50°C Storage temperature: -40°C to 70°C
Humidity	Operating humidity: 10% to 90% RH Storage humidity: 5% to 95% RH
Altitude	0 to 5000m
Fan	Speed adjustment and fault alarm
Temperature Alarm	Supported
EMI Standard	GB9254-2008CLASS A
Safety Standard	GB4943-2011

Dimensions (W x D x H)	440 mm x 340 mm x 44 mm
Weight	4.7kg

Product Appearance

The RG-S5750C-48SFP4XS-H Ethernet switch provides 48 GE SFP ports, 4 10GE SFP+ ports, 1 MGMT port, 1 USB port, 1 Mini USB port, and 1 Console port on the front panel, as well as 2 power module slots and 2 expansion module slots on the back panel.

Figure 1-13 Appearance of RG-S5750C-48SFP4XS-H

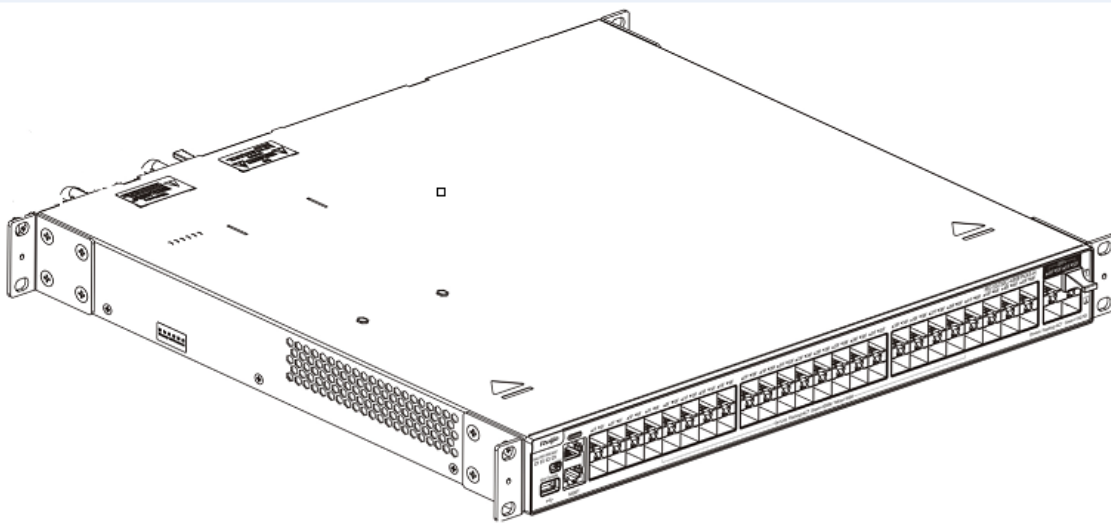

Front Panel

Figure 1-14 Front Panel of RG-S5750C-48SFP4XS-H

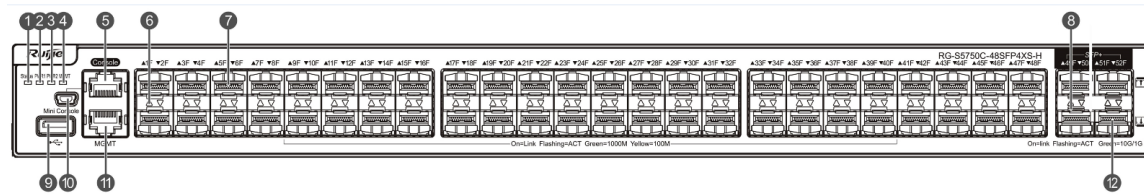

Note:	1. System status LED	7. GE SFP port
	2. Power status LED (PWR1)	8. 10GE SFP+ port status LED
	3. Power status LED (PWR2)	9. USB port
	4. MGMT port status LED	10. Mini USB port
	5. Console port	11. MGMT port
	6. GE SFP port status LED	12. 10GE SFP+ port

Back Panel

Figure 1-15 Back Panel of RG-S5750C-48SFP4XS-H

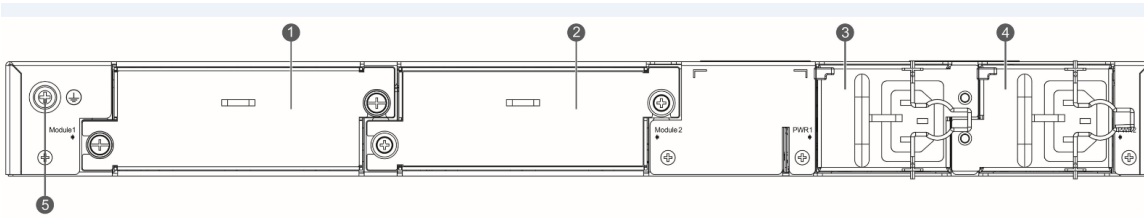

Note:	1. Expansion module slot 1 2. Expansion module slot 2 3. Power module slot 1	4. Power module slot 2 5. Grounding point
-------	--	--

Power Supply

The RG-S5750C-48SFP4XS-H supports RG-PA150I-F. For details, see the section “Power Modules”.

Dual-power input: The switch can be powered by one power module, or two power modules. When both two modules are available, the switch is in redundancy mode.

⚠ When the switch is powered by the dual-power modules, if the system working power is greater than the capacity of single power module, power redundancy cannot work; if one power module fails, the switch system will be affected.

Heat Dissipation

The RG-S5750C-48SFP4XS-H is designed with left and right fans for heat dissipation, thereby ensuring the normal function of the device in the specified environment. Sufficient space (10 cm distance from both sides and the back panel of the cabinet) should be reserved to allow air circulation.

Figure 1-16 Flow Scheme of Heat Dissipation

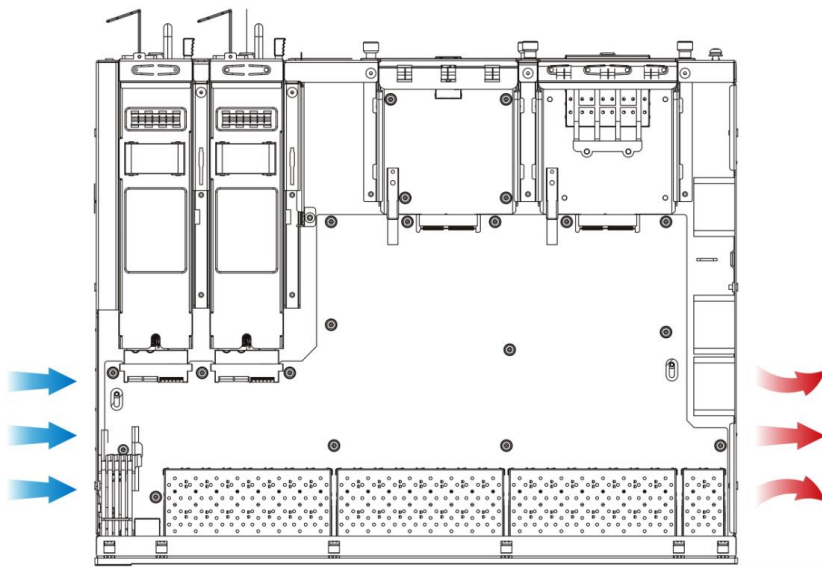

LED

LED	Panel Identification	State	Meaning
System status LED	Status	Off	The switch is not receiving power.
		Blinking green (3 Hz)	The switch is being initialized with 3Hz blinking. Continuous blinking indicates errors.
		Blinking green	Supports remote on/off to locate the switch.

LED	Panel Identification	State	Meaning
		(10Hz)	
		Solid green	The switch is operational.
		Solid yellow	Temperature alarm: 1. Temperature of inlet/outlet air exceeds the normal operating temperature range. 2. The power supplies cannot support the whole system. Check the working environment of the switch and power supplies immediately.
Power status LED	PWR1/PWR2	Solid red	The switch is faulty. For details, see the chapter "Troubleshooting".
		Off	The power module is not in place or not receiving power.
		Solid green	The power module is in place and can supply power.
MGMT port status LED	MGMT	Solid red	The redundant power is faulty or the AC power cord is not connected.
		Off	The port is not connected.
		Solid green	The port is connected at 1000 Mbps.
10GE SFP+ port status LED	49F-52F	Blinking green	The port is receiving or transmitting traffic at 1000 Mbps.
		Solid yellow	The port is connected at 10/100 Mbps.
		Blinking yellow	The port is receiving or transmitting traffic at 10/100 Mbps.
GE SFP port status LED	1F-48F	Off	The port is not connected.
		Solid green	The port is connected at 1/10 Gbps.
		Blinking green	The port is receiving or transmitting traffic at 1/10 Gbps.
		Solid yellow	The port is connected at 100 Mbps.
		Blinking yellow	The port is receiving or transmitting traffic at 100 Mbps.

1.5 RG-S5750-48GT4XS-HP-H

Technical Specifications

Model	RG-S5750-48GT4XS-HP-H
CPU	Dual-core with each 1.0 GHz

BOOTROM	8 MB
Flash Memory	512 MB
SDRAM	1 GB
Optical Module	<p>See <i>Appendix B</i>.</p> <p> The supported module type may change at any time. Consult the Ruijie Networks for the latest information.</p>
Power Module Slot	<ul style="list-style-type: none"> ● RG-M5000E-AC500P Rated voltage: 100V to 240V Frequency: 50/60Hz Rated current: 7A to 3.5A HVDC Input: Voltage range: 192V to 288V Current range: 3.5A to 2.5A ● RG-PA1150P-F Rated voltage: 100V to 240V Frequency: 50/60Hz Rated current: 10A HVDC Input: Voltage range: 192V to 288V Rated current: 10A ● RG-M5000E-DC500P Voltage range: -36V to -72V Rated current: 16.5A
SFP Port	Not supported
SFP+ Port	10GBase-R 1000Base-X
PoE	All RJ45 ports support PoE. Each port supports up to 30W PoE. The max power is subject to the configured power supply.
PoE Wire Pair	Mode A (wire pair 1-2, 3-6)
Power Consumption	Power consumption (PoE excluded) <60W Power consumption (PoE included) <1500W
Temperature	Operating temperature: 0 °C to 50°C Storage temperature: -40°C to 70°C
Humidity	Operating humidity: 10% to 90% RH

	Storage humidity: 5% to 95% RH
Altitude	0 to 5000m
Fan	Speed adjustment and fault alarm
Temperature Alarm	Supported
EMI Standard	GB9254-2008CLASS A
Safety Standard	GB4943-2011
Dimensions (W x D x H)	440 mm x 420 mm x 44 mm
Weight	6.1kg

Product Appearance

The RG-S5750-48GT4XS-HP-H Ethernet switch provides 48 10/100/1000Base-T Ethernet ports, 4 10GE SFP+ ports, 1 MGMT port, 1 USB port, 1 Mini USB port, and 1 Console port on the front panel, as well as 2 power module slots on the back panel. (When they are connected meanwhile, the Mini USB port prevails).

Figure 1-17 Appearance of RG-S5750-48GT4XS-HP-H

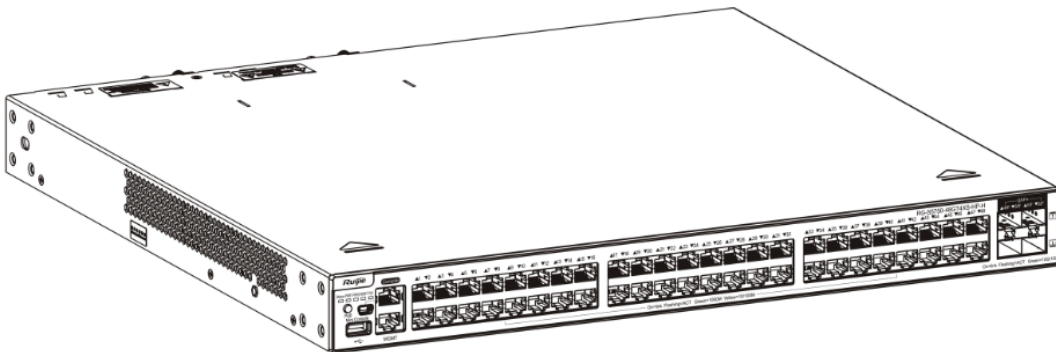

Front Panel

Figure 1-18 Front Panel of RG-S5750-48GT4XS-HP-H

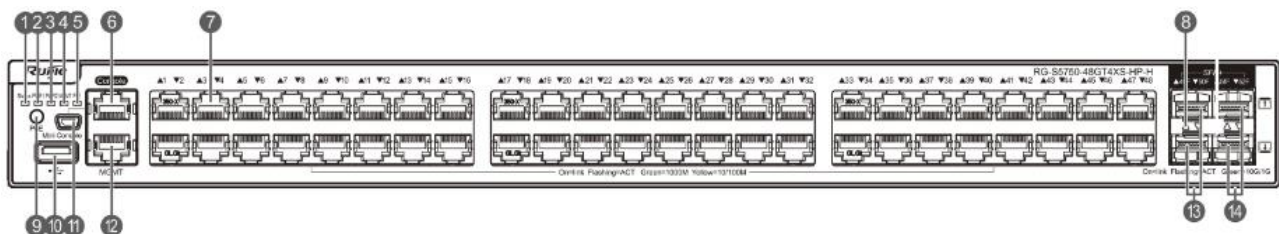

<p>Note:</p>	<ol style="list-style-type: none"> 1. System status LED 2. Power status LED (PWR1) 3. Power status LED (PWR2) 4. MGMT port status LED 5. PoE status LED 6. Console port 7. 10/100/1000Base-T Ethernet port 	<ol style="list-style-type: none"> 8. Switch port status LED 9. PoE button 10. USB port 11. Mini USB port 12. MGMT port 13/14. 10GE SFP+ port
--------------	---	---

Back Panel

Figure 1-19 Back Panel of RG-S5750-48GT4XS-HP-H

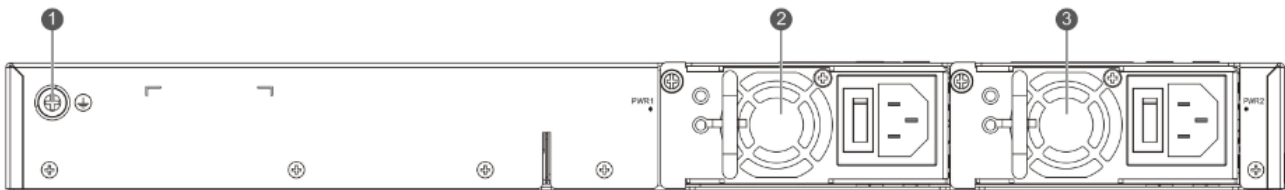

<p>Note:</p>	<ol style="list-style-type: none"> 1. Grounding connector 2. Expansion module slot 1 3. Expansion module slot 2 	
--------------	--	--

Power Supply

RG-S5750-48GT4XS-HP-H supports 2 power modules. For details, see the section “Power Modules”.

Dual-power input: The switch can be powered by one power module, or two power modules. When both two modules are available, the switch is powered in current sharing mode.

⚠ When the switch is powered by the dual-power modules, if the system working power is greater than the capacity of single power module, power redundancy cannot work; if one power module fails, the switch system will be affected.

Heat Dissipation

The RG-S5750-48GT4XS-HP-H is designed with left and right fans for heat dissipation, thereby ensuring the normal function of the device in the specified environment. Maintain a minimum clearance of 10cm around the chassis to allow air circulation.

Figure 1-20 Flow Scheme of Heat Dissipation

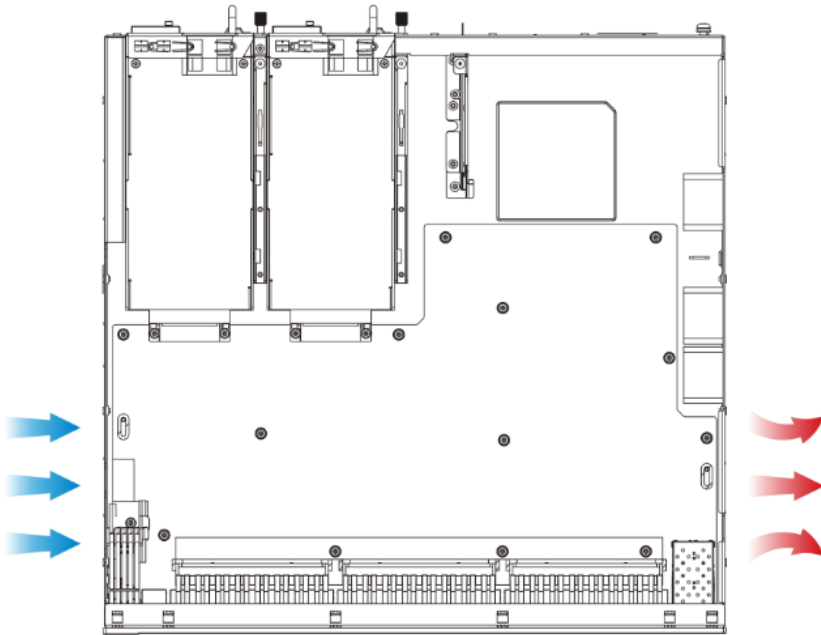

LED

LED	Panel Identification	State	Meaning
System status LED	Status	Off	The switch is not receiving power.
		Blinking green (3 Hz)	The switch is being initialized with 3Hz blinking. Continuous blinking indicates errors.
		Blinking green (10Hz)	Supports remote on/off to locate the switch.
		Solid green	The switch is operational.
		Solid yellow	Temperature alarm: 1. Temperature of inlet/outlet air exceeds the normal operating temperature range. 2. The power supplies cannot support the whole system. 3. RG-PA1150P-F is used with RG-M5000E-AC500P/RG-M5000E-DC500P Check the working environment of the switch and power supplies immediately.
Solid red	The switch is faulty. For details, see the chapter "Troubleshooting".		
Power status LED	PWR1/PWR2	Off	The power module is not in place or not receiving power.
		Solid green	The power module is connected and can supply power.
		Solid red	The redundant power is faulty or the AC power cord is not connected.
PoE status LED	PoE	Solid green	Switching status
		Solid yellow	PoE power supply status
MGMT port status	MGMT	Off	The port is not connected.

LED	Panel Identification	State	Meaning
LED		Solid green	The port is connected at 1000 Mbps.
		Blinking green	The port is receiving or transmitting traffic at 1000 Mbps.
		Solid yellow	The port is connected at 10/100 Mbps.
		Blinking yellow	The port is receiving or transmitting traffic at 10/100 Mbps.
10GE SFP+ port status LED	49F-52F	Off	The port is not connected.
		Solid green	The port is connected at 1/10 Gbps.
		Blinking green	The port is receiving or transmitting traffic at 1/10 Gbps.
10/100/1000Base-T Ethernet port status LED	1-48	Off	The port is not connected.
		Solid green	The port is connected at 1000 Mbps.
		Blinking green	The port is receiving or transmitting traffic at 1000 Mbps.
		Solid yellow	The port is connected at 10/100 Mbps.
		Blinking yellow	The port is receiving or transmitting traffic at 10/100 Mbps.
RJ45 port PoE status LED	1-48	Off	PoE is off.
		Solid green	PoE is on.
		Solid yellow	PoE overload occurs.

1.6 RG-S5750-24GT4XS-HP-H

Technical Specifications

Model	RG-S5750-24GT4XS-HP-H
CPU	Dual-core with each 1.0 GHz
BOOTROM	8 MB
Flash Memory	512 MB
SDRAM	1 GB
Optical Module	<p>See <i>Appendix B</i>.</p> <p> The supported module type may change at any time. Consult the Ruijie Networks for the latest information.</p>
Power Module Slot	<ul style="list-style-type: none"> RG-M5000E-AC500P <p>Rated voltage: 100V to 240V</p> <p>Frequency: 50/60Hz</p> <p>Rated current: 7A to 3.5A</p> <p>HVDC Input:</p>

	<p>Voltage range: 192V to 288V</p> <p>Current range: 3.5A to 2.5A</p> <ul style="list-style-type: none"> ● RG-PA1150P-F <p>Rated voltage: 100V to 240V</p> <p>Frequency: 50/60Hz</p> <p>Rated current: 10A</p> <p>HVDC Input:</p> <p>Voltage range: 192V to 288V</p> <p>Rated current: 10A</p> <ul style="list-style-type: none"> ● RG-M5000E-DC500P <p>Voltage range: -36V to -72V</p> <p>Rated current: 16.5A</p>
SFP Port	Not supported
SFP+ Port	10GBbase-R 1000Base-X
PoE	All RJ45 ports support PoE. Each port supports up to 30W PoE. The max power is subject to the configured power supply.
PoE Wire Pair	Mode A (wire pair 1-2, 3-6)
Power Consumption	Power consumption (PoE excluded) <60W Power consumption (PoE included) <800W
Temperature	Operating temperature: 0 °C to 50°C Storage temperature: -40°C to 70°C
Humidity	Operating humidity: 10% to 90% RH Storage humidity: 5% to 95% RH
Altitude	0 to 5000m
Fan	Speed adjustment and fault alarm
Temperature Alarm	Supported
EMI Standard	GB9254-2008CLASS A
Safety Standard	GB4943-2011
Dimensions (W x D x H)	440 mm x 420 mm x 44 mm
Weight	7.9kg

Product Appearance

The RG-S5750-24GT4XS-HP-H Ethernet switch provides 24 10/100/1000Base-T Ethernet ports, 4 10GE SFP+ ports, 1 MGMT port, 1 USB port, and 1 Console port on the front panel, as well as 2 power module slots on the back panel.

Figure 1-21 Appearance of RG-S5750-24GT4XS-HP-H



Front Panel

Figure 1-22 Front Panel of RG-S5750-24GT4XS-HP-H

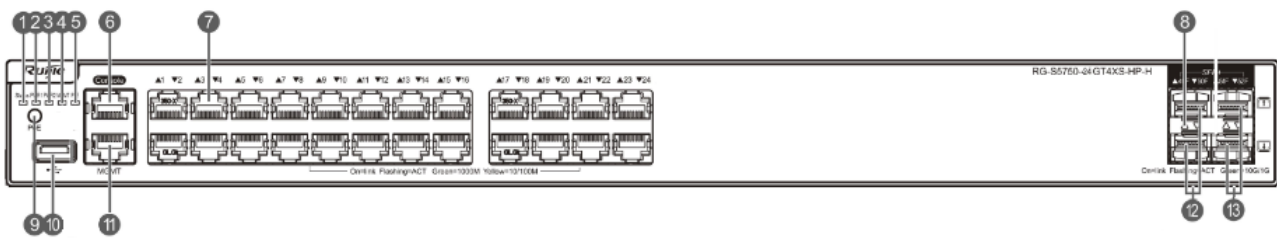

<p>Note:</p>	<ol style="list-style-type: none"> 1. System status LED 2. Power status LED (PWR1) 3. Power status LED (PWR2) 4. MGMT port status LED 5. PoE status LED 6. Console port 7. 10/100/1000Base-T Ethernet port 	<ol style="list-style-type: none"> 8. Switch port status LED 9. PoE button 10. USB port 11. MGMT port 12/13. 10GE SFP+ port
--------------	---	--

Back Panel

Figure 1-23 Back Panel of RG-S5750-24GT4XS-HP-H



<p>Note:</p>	<ol style="list-style-type: none"> 1. Grounding connector 2. Expansion module slot 1 3. Expansion module slot 2
--------------	--

Power Supply

RG-S5750-24GT4XS-HP-H supports 2 power modules. For details, see the section “Power Modules”.

Dual-power input: The switch can be powered by one power module, or two power modules. When both two modules are available, the switch is powered in current sharing mode.

⚠ When the switch is powered by the dual-power modules, if the system working power is greater than the capacity of single power module, power redundancy cannot work; if one power module fails, the switch system will be affected.

Heat Dissipation

The RG-S5750-24GT4XS-HP-H is designed with left and right fans for heat dissipation, thereby ensuring the normal function of the device in the specified environment. Maintain a minimum clearance of 10cm around the chassis to allow air circulation.

Figure 1-24 Flow Scheme of Heat Dissipation

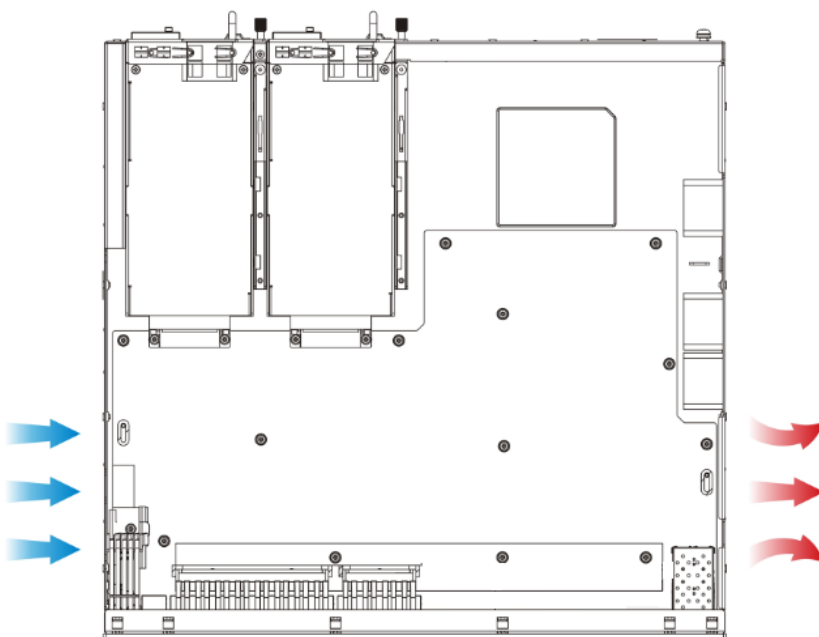

LED

LED	Panel Identification	State	Meaning
System status LED	Status	Off	The switch is not receiving power.
		Blinking green (3 Hz)	The switch is being initialized with 3Hz blinking. Continuous blinking indicates errors.
		Blinking green (10Hz)	Supports remote on/off to locate the switch.
		Solid green	The switch is operational.
		Solid yellow	Temperature alarm: 1. Temperature of inlet/outlet air exceeds the normal operating temperature range. 2. The power supplies cannot support the whole system. 3. RG-PA1150P-F is used with

LED	Panel Identification	State	Meaning
			RG-M5000E-AC500P/RG-M5000E-DC500P Check the working environment of the switch and power supplies immediately.
		Solid red	The switch is faulty. For details, see the chapter "Troubleshooting".
Power status LED	PWR1/PWR2	Off	The power module is not in place or not receiving power.
		Solid green	The power module is connected and can supply power.
		Solid red	The redundant power is faulty or the AC power cord is not connected.
PoE status LED	PoE	Solid green	Switching status
		Solid yellow	PoE power supply status
MGMT port status LED	MGMT	Off	The port is not connected.
		Solid green	The port is connected at 1000 Mbps.
		Blinking green	The port is receiving or transmitting traffic at 1000 Mbps.
		Solid yellow	The port is connected at 10/100 Mbps.
		Blinking yellow	The port is receiving or transmitting traffic at 10/100 Mbps.
10GE SFP+ port status LED	25F-28F	Off	The port is not connected.
		Solid green	The port is connected at 1/10 Gbps.
		Blinking green	The port is receiving or transmitting traffic at 1/10 Gbps.
10/100/1000Base-T Ethernet port status LED	1-24	Off	The port is not connected.
		Solid green	The port is connected at 1000 Mbps.
		Blinking green	The port is receiving or transmitting traffic at 1000 Mbps.
		Solid yellow	The port is connected at 10/100 Mbps.
		Blinking yellow	The port is receiving or transmitting traffic at 10/100 Mbps.
RJ45 port PoE status LED	1-24	Off	PoE is off.
		Solid green	PoE is on.
		Solid yellow	PoE overload occurs.

1.7 Expansion Modules

The RG-S5750-48GT4XS-H and RG-S5750C-48SFP4XS-H series switches support the following modules: M5000H-04XS, M5000H-01QXS and M5000H-MSA.

 M5000H-04XS is only supported on the expansion module slot 1 of RG-S5750C-48GT4XS-H and RG-S5750C-48SFP4XS-H.

The RG-S5750C-28GT4XS-H and RG-S5750C-28SFP4XS-H series switches support the following modules: M5000H-01QXS and M5000H-MSA.

Module	Description	External port
M5000H-04XS	4-port 10GE optical module	4 SFP+ ports
M5000H-01QXS	1-port stack module	1 QSFP+ port

i For the detailed description about those two modules, see *Switch Extension Module Manual*.

1.8 Power Modules

At present, RG-S5750C-28GT4XS-H, RG-S5750C-28SFP4XS-H and RG-S5750C-48GT4XS-H series switches support the swappable RG-PA70I and RG-PD70I power module. The RG-PA70I power module provides AC (HVDC) input and DC output, 12V voltage output and up to 70W power output to the switch. And the RG-PD70I power module provides DC input, 12V voltage output and up to 70W power output to the switch.

RG-S5750C-48SFP4XS-H supports RG-PA150I-F.

- i** RG-S5750-48GT4XS-HP-H and RG-S5750-24GT4XS-HP-H support RG-M5000E-AC500P, RG-M5000E-DC500P and RG-PA1150P-F. RG-S5750C-28GT4XS-H, RG-S5750C-28SFP4XS-H and RG-S5750C-48GT4XS-H support only the RG-PA70I and RG-PD70I power module. Do not apply other power modules.
- i** RG-S5750C-48SFP4XS-H only supports RG-PA150I-F.
- i** RG-S5750-48GT4XS-HP-H and RG-S5750-24GT4XS-HP-H only support RG-M5000E-AC500P, RG-M5000E-DC500P and RG-PA1150P-F.
- i** The switch can be powered by one power module, or two power modules. When both two modules are available, the switch is powered in current sharing mode.
- i** If the system uses dual power supplies and the working power is greater than the max power provided by one single power supply, the redundancy function is not available. If one power supply fails, the system function may be affected.

RG-PA70I

Specification

Power Model	RG-PA70I (AC input)	RG-PA70I (HVDC input)
Device Model	RG-S5750C-28GT4XS-H RG-S5750C-28SFP4XS-H RG-S5750C-48GT4XS-H	RG-S5750C-28GT4XS-H RG-S5750C-28SFP4XS-H RG-S5750C-48GT4XS-H
Rated Voltage	100V to 240V 50/60 Hz	240V
Maximum Voltage	90V to 264V 47/63Hz	192V to 288V
Input Current	2A	
Output Voltage	12V	

Max Current Output	5.83A
Max Power Output	70W
Input Leakage Current	≤1.75mA
Dimensions (L x W x H)	156 mm x 50.5 mm x 38 mm
Weight	≈0.395 kg
Temperature	Operating temperature: -10°C to 50°C Storage temperature: -40°C to 70°C
Humidity	Operating humidity: 10% to 90% Storage humidity: 5% to 95%
Altitude	0 m to 5,000 m

Features

Feature	Description
Conformal Coating	Protects circuits against moisture, frog, mould, electrical shock and leakage, and so on.
Protection	Provides protection over over-voltage/current input/output, short-circuit output and so on.
I2C Communication	Allows the host to communicate with the power module by I2C.
Power Supply Redundancy	Supports dual power modules to cooperate in parallel, enabling PE with 1+1 redundancy and redundant power supplies with current sharing.
Hot Swapping	Supports to disconnect one redundant power module from the outside power supply system, plug and unplug power modules while the device is powered on.
Power Supply Alarm	Alarms power supply faults through the power status LED.

LED

LED	Panel Identification	State	Meaning
Status LED	DC OK	Off	There is no power input or input under voltage.
		Solid green	The module is operational.

RG-PD70I

Specification

Power Model	RG-PD70I (DC input)
Device Model	RG-S5750C-28GT4XS-H, RG-S5750C-28SFP4XS-H, RG-S5750C-48GT4XS-H
Rated Voltage	-36V to -72V
Input Current	3.15A
Output Voltage	12V
Max Current Output	5.83A
Max Power Output	70W
Dimensions (L x W x H)	156mm x 50.5mm x 38mm
Weight	0.385 kg

Temperature	Operating temperature: -10°C to +50°C Storage temperature: -40°C to +70°C
Humidity	Operating humidity: 10% to 90% Storage humidity: 5% to 95%
Altitude	0 m to 5,000 m

Features

Feature	Description
Conformal Coating	Protects circuits against moisture, frog, mould, electrical shock and leakage, and so on.
Protection	Provides protection over over-voltage/current input/output, short-circuit output and so on.
I2C Communication	Allows the host to communicate with the power module by I2C.
Power Supply Redundancy	Supports dual power modules to cooperate in parallel, enabling PE with 1+1 redundancy and redundant power supplies with current sharing.
Hot Swapping	Supports to disconnect one redundant power module from the outside power supply system, plug and unplug power modules while the device is powered on.
Power Supply Alarm	Alarms power supply faults through the power status LED.

LED

LED	Panel Identification	State	Meaning
Status LED	OUT	Off	There is no power output or output error.
		Solid green	The module is operational.

RG-PA150I-F

Specification

Power Model	RG-PA150I-F (AC input)	RG-PA150I-F (HVDC input)
Device Model	RG-S5750C-48GT4XS-H	RG-S5750C-48GT4XS-H
Rated Voltage	100V to 240V 50/60 Hz	240V
Maximum Voltage	90V to 264V 47/63Hz	192V to 288V
Input Current	3A	
Output Voltage	12V	
Max Current Output	12.5A	
Max Power Output	150W	
Input Leakage Current	≤3.5mA	
Dimensions (L x W x H)	196 mm x 50.5 mm x 40mm	
Weight	≈0.55 kg	
Temperature	Operating temperature: -10°C to 55°C Storage temperature: -40°C to 70°C	

Humidity	Operating humidity: 5% to 95% Storage humidity: 5% to 95%
Altitude	0 m to 5,000 m

Features

Feature	Description
Conformal Coating	Protects circuits against moisture, frog, mould, electrical shock and leakage, and so on.
Protection	Provides protection over over-voltage/current input/output, short-circuit output and so on.
I2C Communication	Allows the host to communicate with the power module by I2C.
Power Supply Redundancy	Supports dual power modules to cooperate in parallel, enabling PE with 1+1 redundancy and redundant power supplies with current sharing.
Hot Swapping	Supports to disconnect one redundant power module from the outside power supply system, plug and unplug power modules while the device is powered on.
Power Supply Alarm	Alarms power supply faults through the power status LED.

LED

LED	Panel Identification	State	Meaning
Status LED	OUT	Off	There is no power output or output error occurs.
		On	Output is OK.

RG-M5000E-AC500P

Specification

Power Model	RG-M5000E-AC500P (AC input)	RG-M5000E-AC500P (HVDC input)
Device Model	RG-S5750-48GT4XS-HP-H RG-S5750-24GT4XS-HP-H	RG-S5750-48GT4XS-HP-H RG-S5750-24GT4XS-HP-H
Rated Voltage	100V to 240V 50/60 Hz	240V
Maximum Voltage	90V to 264V 50/60Hz	192V to 288V
Power	Single power supply: 370W for PoE. Dual power supplies: 740W for PoE	
Input Current	≤3.5mA	
Hot Plugging	Supported	
Power Redundancy	1+1 redundancy (PoE is smaller than 370W)	
Over Voltage Protection	54V: -57V to -60V 12V: 13.4V to 16V	
Over Current Protection	54V: 8A to 10A 12V: 12A to 16A	
Over Temperature Protection	Supported	
Current Sharing	Supported	
Mixed Power Utilization	RG-M5000E-DC500P is supported	

Power Cord	10A power cord
Power Dimension (L x W x H)	195.4mm*90mm*40mm (excluding connection finger and bracket) 224.5mm*90mm*40mm (including connection finger and bracket)
Weight	0.9KG
Altitude	0 m to 5,000 m

LED

LED	Panel Identification	State	Meaning
Status LED	OUT	Solid red	There is no power output or output error occurs.
		Solid green	Output is OK.
Status LED	IN	Solid red	Input error.
		Solid green	Input is OK.

RG-M5000E-DC500P

Specification

Power Model	RG-M5000E-DC500P
Device Model	RG-S5750-48GT4XS-HP-H, RG-S5750-24GT4XS-HP-H
Rated Voltage	-36V to -72V
Input Current	16.5A
Power	Single power supply: 370W for PoE. Dual power supplies: 740W for PoE
Input Current	≤3.5mA
Hot Plugging	Supported
Power Redundancy	1+1 redundancy (PoE is smaller than 370W)
Over Voltage Protection	54V: -58V to -66V 12V: 13.2V to 15.6V
Over Current Protection	54V: 7.8A to 10A 12V: 11A to 14A
Over Temperature Protection	Supported
Current Sharing	Supported
Mixed Power Utilization	RG-M5000E-AC500P is supported.
Power Cord	PD650I DC power cord
Power Dimension (L x W x H)	195.4mm*90mm*43.2mm (excluding connection finger and bracket) 224.5mm*90mm*43.2mm (including connection finger and bracket)
Weight	0.8KG
Altitude	0 m to 5,000 m

LED

LED	Panel Identification	State	Meaning
Status LED	OUT	Solid red	There is no power output or output error occurs.
		Solid green	Output is OK.

Status LED	IN	Solid red	Input error.
		Solid green	Input is OK.

RG-PA1150P-F

Specification

Power Model	RG-PA1150P-F (AC input)	RG-PA1150P-F (HVDC input)
Device Model	RG-S5750-48GT4XS-HP-H RG-S5750-24GT4XS-HP-H	RG-S5750-48GT4XS-HP-H RG-S5750-24GT4XS-HP-H
Rated Voltage	100V to 240V 50/60 Hz	240V
Maximum Voltage	90V to 264V 50/60Hz	192V to 288V
Power	Voltage Input: 175VAC to 240VAC	740W for single power module 1480W for dual power modules
	Voltage Input: 90VAC to 175VAC	370W for single power module 740W for dual power modules
Input Current	≤3.5mA	
Hot Plugging	Supported	
Power Redundancy	1+1 redundancy (Voltage input: 175VAC to 240VAC. Power: < 740W)	
Over Voltage Protection	54V: -57V to -60V 12V: 14V to 16V	
Over Current Protection	54V: 16.5A to 20A 12V: 32A to 40A	
Over Temperature Protection	Supported	
Current Sharing	Supported	
Mixed Power Utilization	RG-M5000E-AC500P or RG-M5000E-DC500P is not supported.	
Power Cord	10A power cord	
Power Dimension (L x W x H)	281mm*90mm*40mm (excluding connection finger and bracket) 301mm*90mm*40mm (including connection finger and bracket)	
Weight	1.5KG	
Altitude	0 m to 5,000 m	

LED

LED	Panel Identification	State	Meaning
Status LED	OUT	Off	There is no power output or output error occurs.
		Solid green	Output is OK.

2 Preparation before Installation

2.1 Safety Suggestions

To avoid personal injury and equipment damage, please carefully read the safety suggestions before you install the RG-S5750H series.



The following safety suggestions may not cover all possible dangers.

2.1.1 Installation

- Keep the chassis clean and free from dust.
- Do not place the equipment in a passage.
- Do not wear loose clothes or any other things that may be caught by the chassis during installation and maintenance.
- Turn off all power supplies and remove the power sockets and cables before dismantling the cabinet.

2.1.2 Movement

- Do not frequently move the device.
- While moving the device, keep its balance and avoid your legs, feet and back from being hurt.
- Before moving the device, turn off all power supplies and dismantle all power modules.

2.1.3 Electricity

- Observe local regulations and specifications when performing electric operations. Relevant operators must be qualified.
- Carefully check any potential danger in the working area, such as ungrounded power supply, unreliable grounding of the power supply, and damp/wet ground or floor.
- Find out the location of the emergency power supply switch in the room before installation. First cut off the power supply in the case of an accident.
- Do not maintain the switch that is powered-on alone.
- Make sure that the power is turned off when necessary.
- Do not place the equipment in a damp place. Do not let any liquid enter the chassis.



Any non-standard and inappropriate electric operations may cause an accident such as a fire or electrical shock, thus causing severe even fatal damage to human bodies and equipment.





Direct or indirect touch through a wet object on high-voltage and commercial electricity may bring a fatal danger.



If a power supply system is equipped with a leakage protector (also referred to as "leakage current switch" or "leakage current breaker"), the rated leakage action current of each leakage protector is greater than twice of the theoretical maximum leakage current of all the power supplies in the system. For example, if a system is equipped with eight identical power supplies, the leakage current of each power supply is equal to or less than 3 mA, and the leakage current of the system totals 24 mA. A leakage protector with 30 mA rated action current supports less than

five power supplies (that is, Action current of the leakage protector/2/Maximum leakage current of each power supply = $30/2/3 = 5$). In other words, the leakage protector with 30 mA rated action current supports no more than four power supplies. In this case, the eight power supplies in the system require at least two leakage protectors with 30 mA rated action current and each leakage protector supports four power supplies. If power supplies in a system differ in models, the rated leakage action current of each leakage protector divided by two is greater than the sum of maximum leakage currents of all the power supplies. The rated leakage non-action current of a leakage protector shall be 50% of the leakage action current. Take a leakage protector with 30 mA rated leakage action current as an example. The rated leakage non-action current shall be 15 mA. When the leakage current is below 15 mA, the protector shall not act. Otherwise, misoperation may easily occur due to high sensitivity and thus the leakage protector trips, devices are powered off, and services are interrupted.

 To guarantee personal safety, the rated leakage action current of each leakage protector in the system must be equal to or less than 30 mA (human body safety current is 30 mA). When twice of the total leakage current of the system is greater than 30 mA, the system must be equipped with two or more leakage protectors.

 For the leakage current value of each power supply model, see the power supply model parameter table in Chapter 1.

2.1.4 ESD

To prevent Electronic Static Discharge (ESD), pay attention to the following:

- Connect the device's circuit to the ground.
- Clear up the dust.
- Maintain the proper humidity.

2.1.5 Laser

Among the modules supported by the RG-S5750H series, many are Class I laser products. Therefore, pay attention to the following when using them:

- When a fiber transceiver works, ensure that the port has been connected with an optical fiber or is covered with a dust cap, to keep out dust and avoid burning your eyes.
- Do not stare into the optical ports.

 Do not approach or stare into any optical port, as this may cause permanent damage to your eyes.

2.2 Installation Site Requirements

The RG-S5750H series must be used indoors. To ensure its functioning and prolong its service life, the installation site must meet the following requirements.

2.2.1 Ventilation

RG-S5750H should be placed at least 10 cm away from surrounding walls to effective ventilation and heat dissipation. Cables should be bunched or put on the cable frame after being connected in order to prevent blocking the air intake.

2.2.2 Temperature and Humidity

The temperature and humidity in the room must be stable to ensure the device's proper functioning and prolong its service life.

Continuous improper temperature and humidity will cause damage to the device.

High relative humidity will reduce the insulation of insulation materials and cause electric leakage. Sometimes it may lead to changes in the mechanical characters of materials and rust metal components.

Low relative humidity will dry the insulation sheets and generate static electricity, which will damage the electric circuits of the device.

High temperature will large affect the device's reliability, shorten its service life and accelerate its aging.

Temperature and humidity requirements of the RG-S5750H series are as follows:

Temperature	Relative Humidity
0 °C to 50°C	10% to 90%

 The working temperature and humidity are measured 1.5 m above the ground and 0.4 m away from the front plat and when the chassis' front and rear protective plates are removed.

2.2.3 Cleanness

Dust poses the top threat to the running of the equipment. The indoor dust falling on the equipment may be adhered by the static electricity, causing bad contact of the metallic joint. Such electrostatic adherence may occur more easily when the relative humidity is low, not only affecting the use life of the equipment, but also causing communication faults. The following table shows the requirements for the dust content and granularity in the equipment room.

Min Dust Diameter (μm)	0.5	5
Dust Particle (Particles/m³)	≤3.5×10 ⁶	≤3×10 ⁴

Apart from dust, the salt, acid and sulfide in the air in the equipment room must also meet strict requirements; as such poisonous substances may accelerate the corrosion of the metal and the aging of some parts. The equipment room should be protected from the intrusion of harmful gases (for example, SO₂, H₂S, NO₂ and Cl₂), whose requirements are listed in the following table.

Gas	Average (mg/m ³)	Maximum (mg/m ³)
SO ₂	0.3	1.0
H ₂ S	0.1	0.5
NO ₂	0.5	1.0
Cl ₂	0.1	0.3

2.2.4 Grounding

A good grounding system is the basis for the stable and reliable operation of the RG-S5750H series, preventing lightning stroke and resisting interference. Please carefully check the grounding conditions on the installation site according to the grounding requirements, and perform grounding operations properly as required.

 The correct connection of grounding lines guarantees the lightning and interference resistance of switches and must be performed with precision.

Safety Grounding

The equipment using AC power supply must be grounded by using the yellow/green safety grounding cable. Otherwise, when the insulating resistance decreases the power supply and the enclosure in the equipment, electric shock may occur.

Lightning Grounding

The lightning protection system of a facility is an independent system that consists of the lightning rod, downlead conductor and the connector to the grounding system, which usually shares the power reference ground and yellow/green safety cable ground. The lightning discharge ground is for the facility only, but unnecessary for equipment.

EMC Grounding

The grounding required for EMC design includes shielding grounding, filter grounding, noise and interference suppression, and level reference. All the above constitute the comprehensive grounding requirements. The grounding resistance should be less than 1Ω . The RG-S5750H back panel has one grounding connector.

Figure 2-1 Grounding of the RG-S5750H

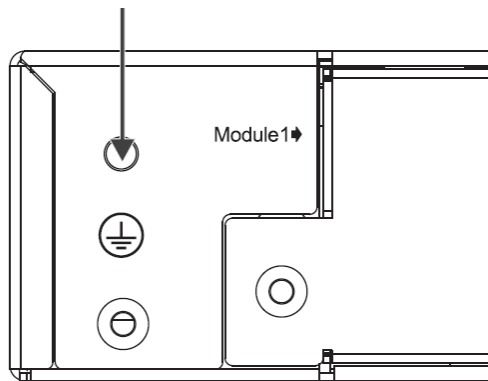

2.2.5 Lightning Resistance

When the AC power cable is imported outdoors and directly connected to the power port of the switch, lightning preventing wires should be adopted to prevent the switch from being hit by lightning shocks. The lightning preventing wires can be fixed on the cabinet, work station, or the equipment room's wall through line buckles and screws. In applications, the AC current first enters the lightning preventing wires and then the switch.

⚠ The lightning preventing wires are not provided and should be purchased by users as required. For the usage of lightning preventing wires, refer to their manuals.

2.2.6 EMI

All kinds of interference, from inside or outside of the device or application system, create impacts on the device by transmission of capacity coupling, inductance coupling and electromagnetic waves.

Electromagnetic interference can be divided into two categories by transmission types, namely i.e. radiated interference and conducted interference.

Power, normally RF power, transmitted from a device through space to a sensor is called radiated interference. The origin of the interference source can either be part of or a unit separated electrically from the interfered system. Conducted interference is transmitted through magnetic wires or signal cables from the source origin to sensors. Generally, conducted interference affects the power supply of a device and can be controlled by a wave filter. Given that radiated interference can interrupt any signal paths of the device, it is difficult to shield the device from such interference.

- The AC power supplying system is the TN system. The single-phase three-wire socket with protecting grounding must be used as the socket for the power supply to enable the device's upper filter circuit to effectively filter the power interface.
- The switch should be far from high-power radio transmitting stations, radar stations and high-frequency and large-current devices.
- Electromagnetic shielding methods should be applied when necessary, such as using the shielded cable as the interface cable.
- Cables must be connected to interfaces inside the room to prevent damage to the device's signal ports caused by over-voltage and over-current generated by thunder and lightning.

2.3 Precautions for Fiber Connections

Before you connect the fibers, check that the optical connector type and fiber type match the optical interface type used. In addition, pay attention to the Tx and Rx directions of the fiber. The Tx end of this device should be connected to the Rx end of the peer device, and the Rx end of this device to the Tx end of the peer device.

2.4 Installation Tools

List of Installation Tools

Common Tools	Phillips screwdriver, flat-head screwdriver, related electric cables and optical cables, bolts, diagonal pliers, straps
Special Tools	Anti-static tools
Meters	Multimeter

 RG-S5750H is not provided with a tool kit. Please prepare tools on your own.

3 Product Installation

! Please ensure that you have carefully read Chapter 2 and make sure that the requirements set forth in Chapter 2 have been met.

3.1 Installation Flowchart

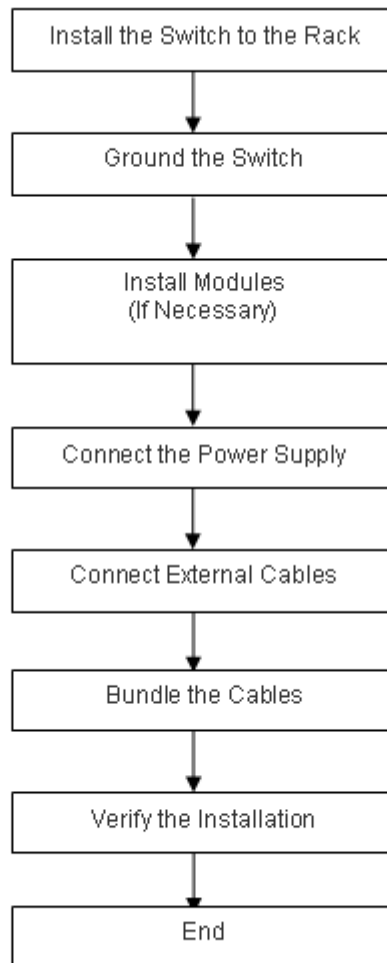

3.2 Pre-installation Confirmation

Before installation, please confirm the following points:

- Whether sufficient airflow is available for the switch
- Whether the requirements of the switch for temperature and humidity are met
- Whether power cables are already laid out and whether the requirements of electrical current are met
- Whether related network cables are already laid out

3.3 Installing the Switch

Precautions

During installation, note the following points:

- Connect the power cables of different colors to the corresponding grounding posts.
- Ensure that the connected power cables have sound contact.
- Do not place heavy items on the switch.
- Reserve a spacing of at least 10 cm around the chassis for good ventilation. Do not stack the devices.
- The switch should be located far away from the large power radio launch pad, radar launch pad, and high-frequency large-current devices. If necessary, electromagnetic shielding should be adopted. For example, use interface cables to shield cables.
- Interface cables should be laid inside the equipment room. Outdoor cabling is prohibited, avoiding damages to device signal interfaces caused by over-voltage or over-current of lightning.

3.3.1 Mounting the Switch in a Standard 19-inch Rack

The RG-S5750H series switches follow the EIA standard dimensions and can be installed in 19-inch rack. During the installation, place the front panel of the switch to the rack. For safety purposes, screw up the distributed screws as shown in the 3-1.

Figure 3-1 Attaching the Mounting Bracket to the Switch

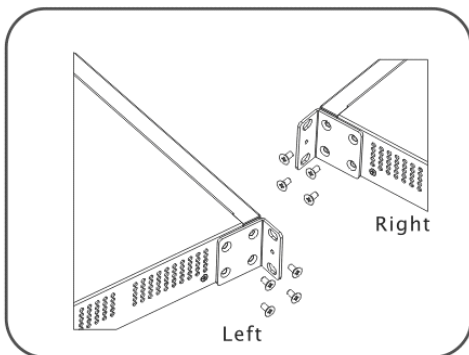

Fix on the 19inch-standards rack

3.3.2 Mounting the Switch on the Wall

The RG-S5750H series switches can be mounted on a wall with the supplied mounting brackets, as shown in Figure 3-2.

Figure 3-2 Attaching the Mounting Brackets to the Switch for Wall-Mounting

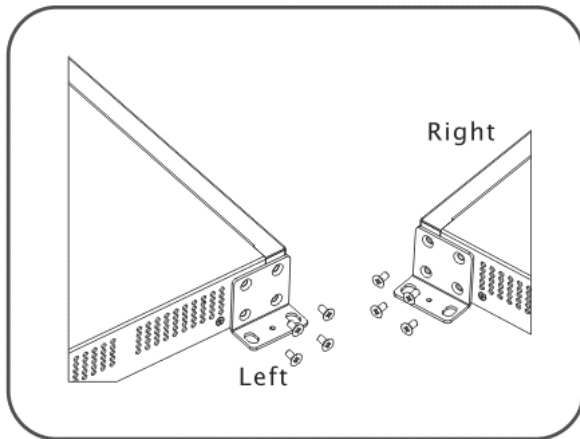

Rotate the fixed frames by 90 degree when it is mounted on the wall

3.3.3 Mounting the Switch on a Table

For often, users may not have a 19-inch rack. Thus, it is common to mount the switch on the workbench with 2 simple steps:

- Attach the four rubber feet to the recessed areas on the bottom of the switch.
- Place the switch on the table and keep good ventilation.

3.4 Installing and Removing the Expansion Modules

! For the M5000H series expansion module, the hardware is hot-swappable while the software does not support hot swapping.

Wear anti-static gloves before the following operations.

Installing an M5000H Series Expansion Module

Step 1: Take off the baffle in the expansion module slot on the front panel of a RG-S5750H series switch.

Step 2: Pinch the captive screws on M5000H. Align M5000H to the guide rail of the expansion module port, and push it to the switch along the rail horizontally and slowly.

Step 3: Tighten the captive screws with a screwdriver to fix M5000H in the switch chassis.

Figure 3-3 Installing an Expansion Module

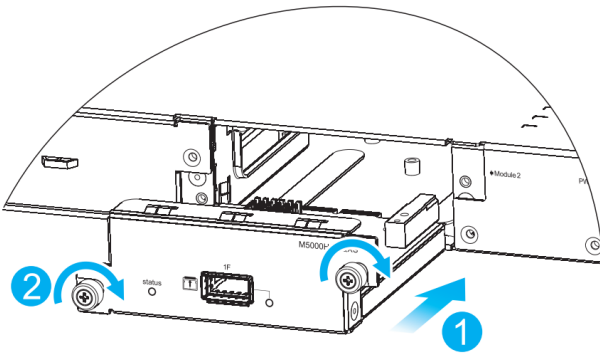

! Insert the expansion module smoothly. Pay attention to the direction of the expansion panel to avoid wrong insertion.

! Do not hold the edge of the PCB or collide the components on the PCB.

! If it is difficult or even impossible to insert the module, pull out the module, make sure the expansion module and guide rail are well aligned, and then insert the module again.

! If the screws cannot be tightened, it is probably because the expansion module is not fully inserted. Please check that carefully.

Removing an M5000H Series Expansion Module

Step 1: Unplug all cables on the panels like optical fiber and RJ45 twisted pairs.

Step 2: Use the screwdriver to loosen the captive screws of the expansion module.

Step 3: Pinch the captive screws and pull out the expansion module along the rail horizontally and slowly.

Step 4: Install a baffle and put the removed expansion module into its package.

Figure 3-4 Removing an Expansion Module

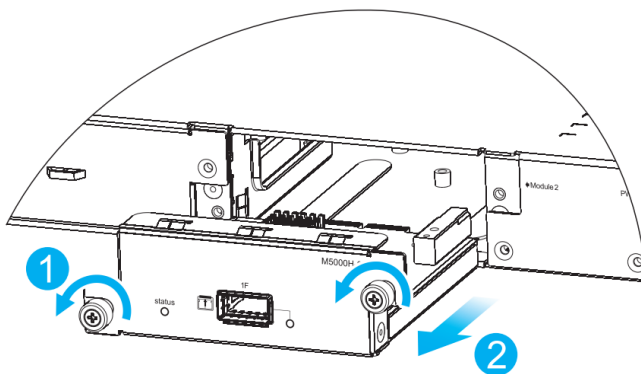

! Withdraw the expansion module uprightly and slowly.

! Do not hold the edge of the PCB or collide the components on the PCB.

! Install a baffle on the location where an expansion module is removed to ensure normal ventilation and dissipation and avoid dust in the chassis.

3.5 Installing and Removing the Power Modules

Wear anti-static gloves before the following operations.

Installing an RG-PA70I or RG-PA150I-F Power Module

Step 1: Take a new power module out of the package and confirm the input mode and the input parameters of the power module match the requirements.

Step 2: Remove the power baffle and take the plane printed with power information as the top panel of the power module. Hold the handle of the power module with one hand, and hold the end of the power module with the other hand. Insert it into the chassis along the guide rail uprightly and slowly until a click is heard, and make sure that it is in good contact with the power slot.

Figure 3-5 Installing a Power Module

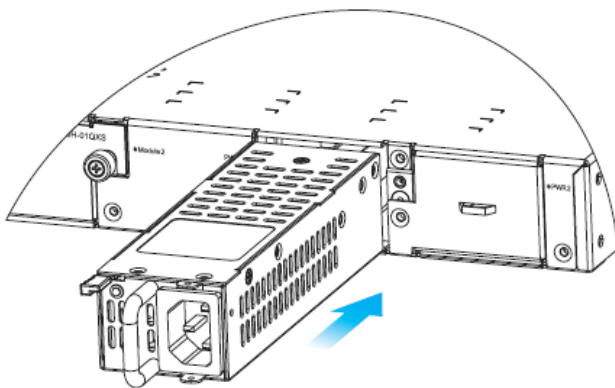

! Insert the power module smoothly. Please pay attention to the direction of the power panel to avoid wrong insertion.

! If it is difficult or even impossible to insert the module, pull out the module, make sure the expansion module and guide rail are well aligned, and then insert the module again.

Removing an RG-PA70I or RG-PA150I-F Power Module

Step 1: Press the plug of the power module, Hold on to the module handle with one hand to pull out part of the module, hold the bottom of it with the other hand, and pull out the power module uprightly and slowly.

Step 2: Install a baffle in the power module slot and put the removed power module into its package.

Figure 3-6 Removing a Power Module

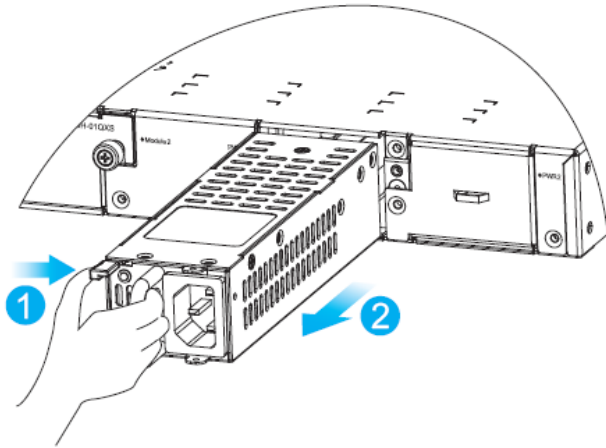

! Remove the power module uprightly and slowly.

! Install a baffle in the location where the power module is removed to ensure the normal ventilation and dissipation and avoid the dust in the chassis.

Installing an RG-PD70I Power Module

Step 1: Take a new power module out of the package and confirm the input mode and the input parameters of the power module match the requirements.

Step 2: Remove the power baffle and take the plane printed with power information as the top panel of the power module. Hold the handle of the power module with one hand, and hold the end of the power module with the other hand. Insert it into the chassis along the guide rail uprightly and slowly until a click is heard, and make sure that it is in good contact with the power slot. The three screws are the input terminals of the DC power module. Remove the screws, and then put the ends of power cables in place before driving the screws back. From left to right, cables are blue, red and yellow-green. Then, remember to cover the terminals with protective caps.

Step 3: Connect the other ends of power cables to the DC panelboard: connect the blue one to the -48VDC terminal, the red one to -48VGND, and the yellow-green one to PGND.

Figure 3-7 Installing a Power Module

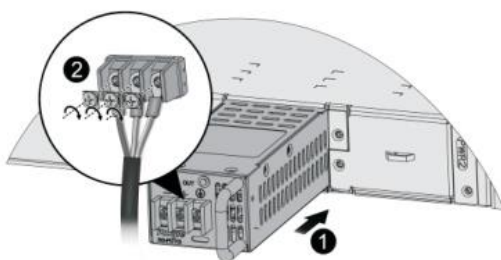
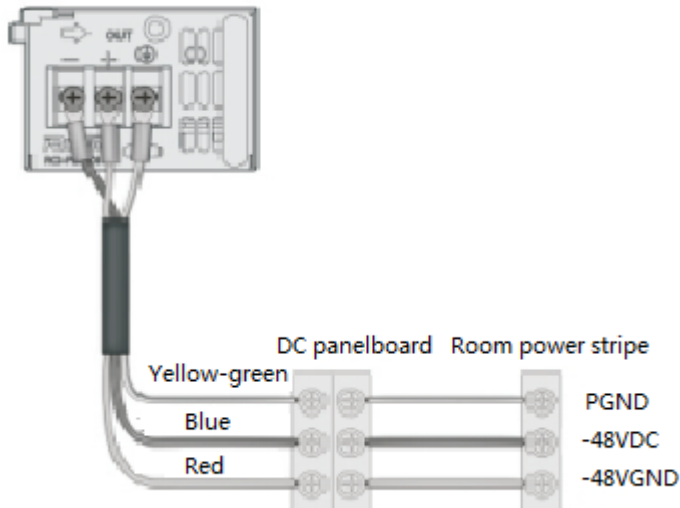

Figure 3-8 Connecting Power Cables to the DC Panelboard



! Insert the power module smoothly. Please pay attention to the direction of the power panel to avoid wrong insertion.

! If it is difficult or even impossible to insert the module, pull out the module, make sure the expansion module and guide rail are well aligned, and then insert the module again.

Removing an RG-PD70I Power Module

Step 1: Press the plug of the power module, Hold on to the module handle with one hand to pull out part of the module, hold the bottom of it with the other hand, and pull out the power module uprightly and slowly.

Step 2: Install a baffle in the power module slot and put the removed power module into its package.

Figure 3-9 Removing a Power Module

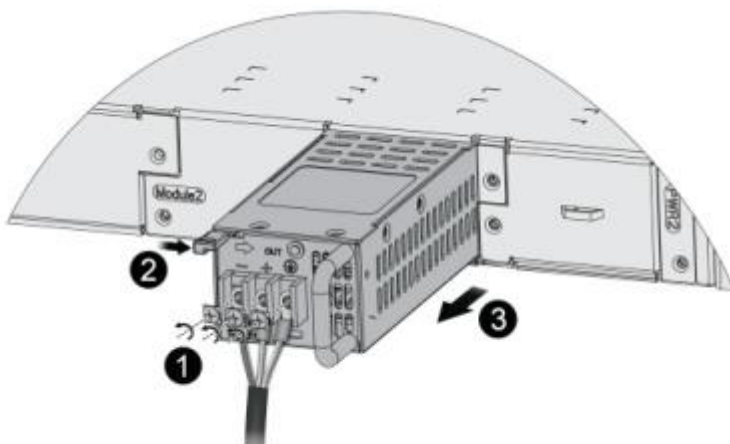

! Remove the power module uprightly and slowly.

! Install a baffle in the location where the power module is removed to ensure the normal ventilation and dissipation and avoid the dust in the chassis.

Installing RG-M5000E-DC500P

If you want to use RG-M5000E-DC500P to provide power for RG-S5750-24GT/8SFP-P or RG-S5750-48GT/4SFP-P, please refer to the following figure and installation steps.

Figure 3-1 Power Supply Connection

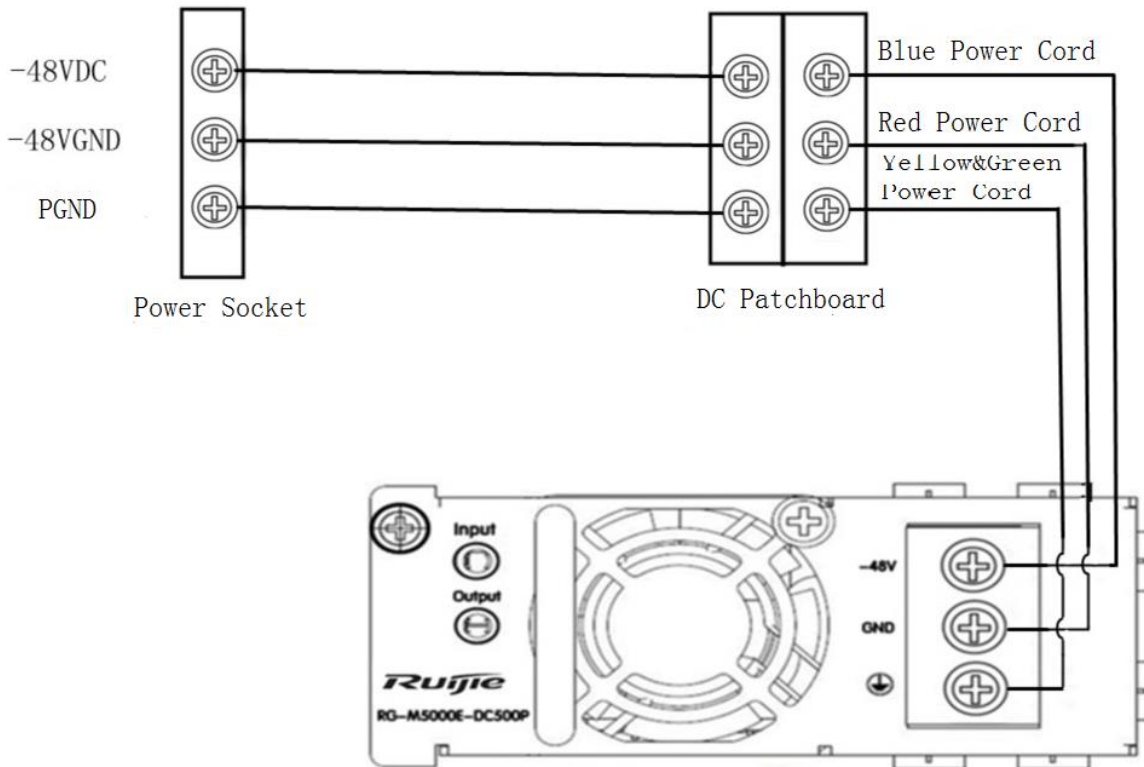

Installation Steps

Take out power supply RG-M5000E-DC500P and DC power cord, and insert the power supply into the power slot.

Take out the insulating cover for power input and loosen the screw.

Plug the power cord into the DC socket.

RG-M5000E-DC500P is supplied with connection cables. The -48V power cable should be blue. The grounding cable should be black. The PGND is yellow and green.

3.6 Grounding the Switch

RG-S5750H has a PGND on the back panel. First connect the PGND to the grounding lug of the rack and then connect the grounding lug to the grounding bar of the equipment room.

Precautions

- The sectional area of the grounding wire should be determined according to the possible maximum current. Cables of good conductor should be used.
- Do not use bare wire.
- The grounding electric resistance should be less than 1Ω.

⚠ To guarantee the security of the body and the device, the switch must be well-grounded. The grounding resistance for combined grounding should be less than 1Ω.

 The maintenance personnel shall check whether or not the AC socket powering the switch is well connected to the building protective earth (PE). If not, the personnel shall connect the grounding lug of the AC socket with the PE by using a grounding connector.

 The AC socket shall be installed near the equipment and shall be easily used.

 When installing the switch, make sure the grounding is connected first and disconnected last.

 The cross-sectional area of PE conductor shall be at least 2.5 mm² (12AWG).

3.7 Connecting the External Port Cables

Precautions

- Correctly distinguish single-mode and multi-mode fibers and ports.
- Avoid bends of small radius at the connector.

Steps

Step 1: Connect one end of the RJ45 connector to the Ethernet interface of the device board, and the other end to the NMS or a control terminal.

Step 2: Insert the single-mode or multi-mode fiber into the appropriate interface according to the identification on the panel of the module.

Step 3: Insert the twisted pair with the RJ45 port into the appropriate interface according to the identification on the panel of the module. Distinguish the crossover cable and straight-through cable.

3.8 Bundling the Cables

Precautions

- The power cables and other cables should be bundled in a pleasing way.
- When you bundle fibers, make sure that the fibers at the connectors have natural bends or bends of large radius.
- Do not bundle fibers and twisted pairs too tightly, as this may press hard the fibers and affect their service time and transmission performance.

Steps

- Bind the drooping part of the fibers and twisted pairs of each board, and lead them to both sides of the chassis for convenience.
- On the both sides of the chassis, fasten the fibers and twisted pairs to the cabinet cable management ring or cabling chute.
- For the power cables, you should bundle them closely along the bottom of the chassis, in a straight line wherever possible.

3.9 Checking after Installation



Before checking the installation, switch off the power supply to avoid any personal injury or damage to the component due to connection errors.

- Check that the ground line is connected.
- Check that the cables and power input cables are correctly connected.
- Check that all interface cables are laid out inside the equipment room. In the case of external cabling, check that the lightning resistance socket or network interface lightning protector is connected.
- Check that sufficient airflow is available around the device (over 10 cm).

4 System Commissioning

4.1 Establishing the Configuration Environment

Establishing the Configuration Environment

Use the Console cable to connect the PC to the switch.

Figure 4-1 Configuration Environment

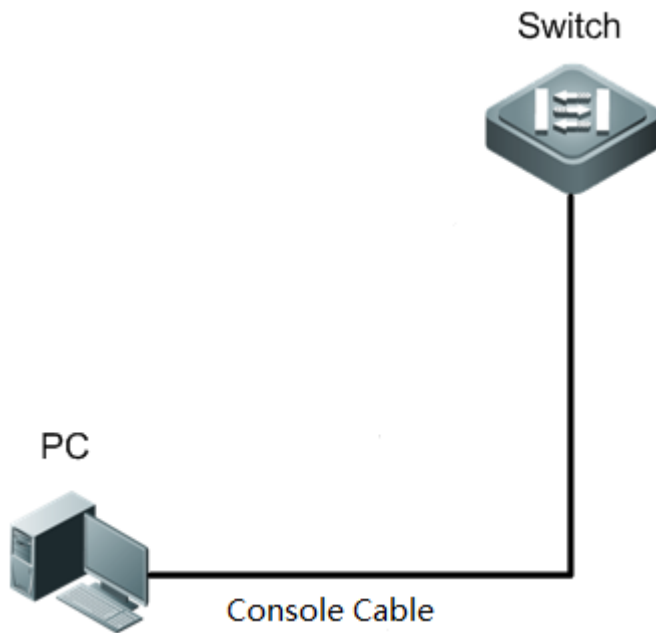

Connecting the Console Cable

The RG-S5750H series switches support the following connecting ways:

Step 1: Connect the serial & Console ports

- Connect the DB-9 end of the Console cable to the serial port of the PC.
- Connect the RJ45 end of the Console cable to the Console port of the switch.

Step 2: Connect the USB & Mini USB ports

- Connect the USB end of the cable to the USB port of the PC.
- Connect the Type-B Mini USB end of the cable to the Mini USB port of the switch.

i RG-S5750H supports Mini USB Console combo by the Mini USB Console driver, which can be downloaded on the TI website. See *Appendix F* for its installation. If both the Mini USB port and Console port are connected, the default Console port is the former.

i When the Mini USB port is connected to PCs, besides the Mini USB Console driver should be installed on PCs and the cable connector is different, other configuration is the same as that of the serial port.

Setting Terminal Parameters

Step 1: Start the PC and run the terminal simulation program on the PC, such as Terminal on Windows 3.1 or HyperTerminal on Windows 95/98/NT/2000/XP.

Step 2: Set terminal parameters. The parameters are as follows: baud rate 9600, data bit 8, parity check none, stop bit 1, and flow control as none.

Choose Setup > Program > Attachment > Communication > Super Terminal.

Choose **Cancel** to display the following page.

Figure 4-2



Enter the name of the new connection and click **OK** to display the following page. Choose the series port used currently in the column [use when connecting].

Figure 4-3

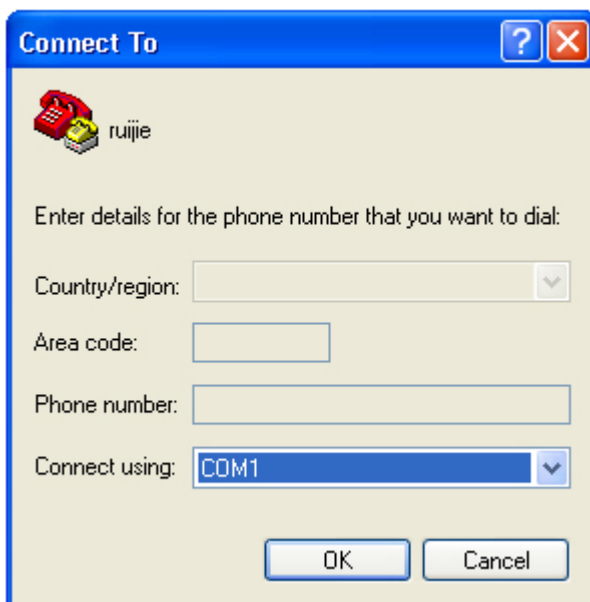

After choosing the series port, click **OK** to display the series port parameter setting page, set the baud rate at 9600, data bit at 8, parity check as none, stop bit at 1 and flow control as none.

Figure 4-4

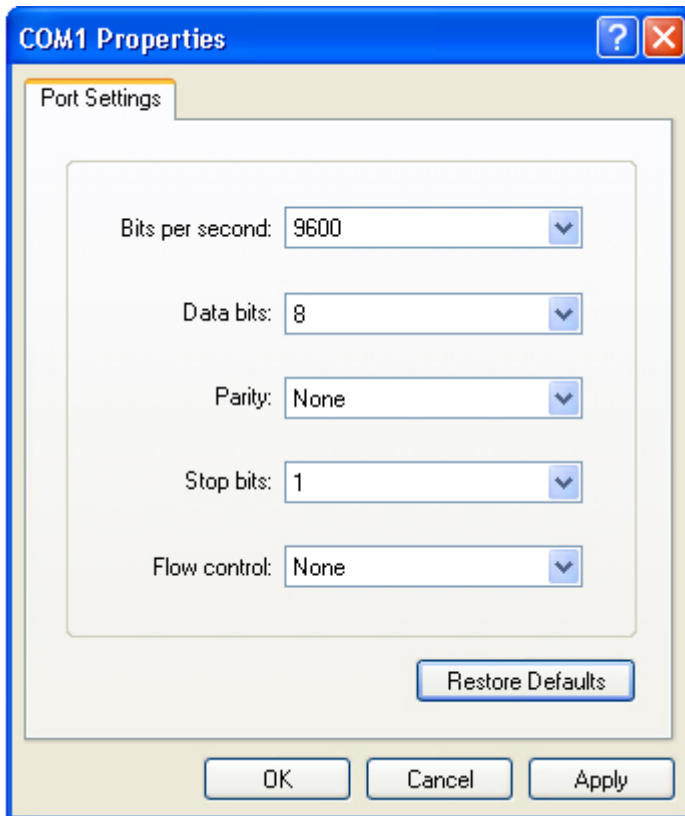

After setting the parameters, click **OK** to enter the super terminal page.

4.2 Power-on Startup

Checking before Power-on

- The switch is fully grounded.
- The power cable is correctly connected.
- The power cable is buckled after connected.
- The power supply voltage complies with the requirement of the switch.
- The console cable is correctly connected; the terminal (can be a PC) used for configuration is already started; the parameters are already configured.

Checking after Power-on (Recommended)

- After power-on, you are recommended to perform the following checks to ensure the normal operation of follow-up configurations.
- Check that information is displayed on the terminal interface.
- Check that the device LEDs are normal.

5 Monitoring and Maintenance

Monitoring LED

When the RG-S5750H is running, users can monitor the status of host and each module by inspecting corresponding LEDs.

- When the system status LED is red, it means the system has a fault, in which case you can determine and eliminate the fault by viewing with the management software.
- When the system status LED is yellow, it means the system temperature exceeds the alarm temperature, affecting the system operation performance. However, the system can continue running. In this case, you can determine and eliminate the fault by viewing with the management software.
- When the system status LED is red or blinking, it indicates a failure, in which case you need to find out the cause, and turn off the power when necessary.
- When power status LED is yellow, it means that the power is not enough to support the host and expansion modules, in which case you should apply RPS modules.
- When the power status LED is red, check whether or not the power cable is in place and operational; if not problem, it means the power supply is faulty, in which case you should replace it promptly.
- When the LED of expansion modules is blinking or red, it means the expansion modules are faulty, in which case you should plug and check the modules.

 The fast green blinking (10Hz) state of the system status LED is used to locate a switch, which should be distinguished from the slow blinking state (3Hz).

CLI Commands

The RG-S5750H allows you to monitor various system states by executing the appropriate CLI commands, including:

- System working status
- Port configuration and status
- Working status of fans and power supplies
- System temperature

 RG-S5750H supports the Data Center Manageability Interface (DCMI) protocol.

 For the configuration and functions, refer to the *Configuration Guide*.

5.1 Hardware Maintenance

Expansion Module Maintenance

If any fault occurs and an expansion module shall be replaced, remove it and install a new one according to the section “Installing and Removing the Expansion Modules”.

Ventilation System Maintenance

- The fan in the equipment responsible for heat dissipation is provided with the fault monitoring signals. When the fan fails, a corresponding alarm will occur.

- Replace the faulty fan with a qualified one.
- Tighten the captive screws of the fan module.

Power Supply Maintenance

When the power supply fails, you only need to disconnect the power cable, unplug the power module, replace it with a qualified one, and then connect the power cables tightly.

Replacing Lithium Battery

The built-in lithium batteries can support the real time clock of the RG-S5750H switch without external power supply.

Please contact the TAC of Ruijie Networks for replacing lithium batteries. Technical staff of Ruijie Networks will replace the battery of the same model.

Replacing Fuses

Please contact the TAC of Ruijie Networks for replacing fuses. Technical staff of Ruijie Networks will replace the fuse of the same model.

6 Troubleshooting

6.1 General Troubleshooting Flowchart

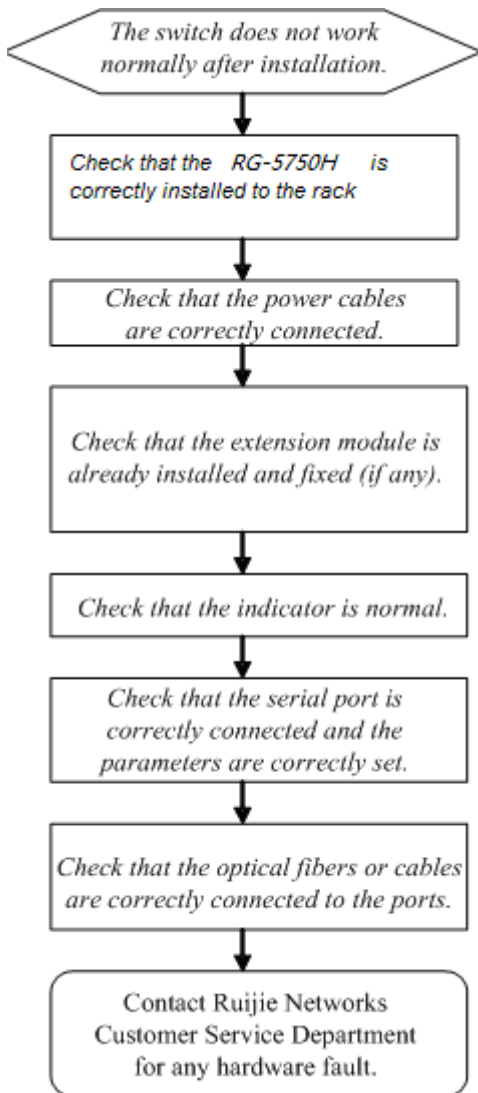

6.2 Troubleshooting Common Faults

Fault 1: The password to login the management interface is lost.

Fault Description:

A password is manually configured but it is forgotten or lost, causing failure in login and configuration.

Troubleshooting:

Contact TAC of Ruijie Networks for technical support.

Fault 2: The AC power module does not work.

Fault Description:

The Status LED of each service module is OFF, the Power LED of the fan tray is OFF, and the fan does not work. The LED on the panel of the power module is OFF. The fan does not work.

Troubleshooting:

First place the switches of all the power modules to OFF. Check if the cables of the cabinet have been correctly connected. Check whether the power cables are tightly connected to the cabinet power sockets and power modules. Check whether the power modules are installed correctly. If necessary, pull out the power modules and check whether the connectors on the backboard of the power system are tightened.

Fault 3: The serial port console has no output.

Fault Description:

After the system is started, the serial port console does not display any information.

Troubleshooting:

Check whether serial port cables are connected correctly and whether the connected serial port is identical with that configured on the super terminal. Check whether the configuration of the serial port on the super terminal is the same as that described in *Configuration Guide*. If not, modify the serial port configuration parameters. If there is still no serial port printed information, please contact TAC of Ruijie Networks for technical support.

Fault 4: The serial port console outputs illegible characters.

Fault Description:

The serial port console outputs illegible characters.

Troubleshooting:

Such problem is related to the settings of the serial port. Check if the settings of such parameters as the baud rate match those in the *Configuration Guide*.

Fault 5: The newly-inserted expansion module fails to be powered on.

Fault Description:

The system is running, yet all LEDs on the panel of the newly-inserted expansion modules are OFF, and the port is faulty.

Troubleshooting:

Check whether the expansion module is connected correctly and whether the PWR1 and PWR2 LEDs turn yellow. If the LEDs become yellow, it means the system is short of power, please add an RPS power module or change the power module. If all checking are OK, but the newly-inserted expansion module still cannot be powered on, please contact TAC of Ruijie Networks for technical support.

Fault 6: The link cannot be set up between fiber interfaces.

Fault Description:

The system runs normally. After the fiber interface is inserted into the optical module and the optical fiber is properly connected, the link cannot be set up.

Troubleshooting:

First confirm whether the interface is a copper/fiber combo interface. If yes, it should be configured in fiber mode. Then, do as follows:

- Check whether the receiving and sending ends are wrongly connected. The sending end of the fiber interface needs to be connected to the receiving end of the other fiber interface. You can check by changing the sequence in which the two optical fibers are connected on the optical module.
- Check whether the optical module wavelengths of the two sides are consistent. For example, an optical module of 1310nm wavelength cannot be connected to an optical module of 1550nm wavelength.
- Check whether the distance between the two sides exceeds the length indicated on the optical module.
- Check whether the rates of the two sides match and whether the optical fiber type meets requirements. In addition, for ports supporting different rate, check whether rate modes are configured correctly.

Appendix A Connectors and Connection Media

1000BASE-T/100BASE-TX/10BASE-T Ports

The 1000BASE-T/100BASE-TX/10BASE-T is a port that supports adaptation of three rates, and automatic MDI/MDIX Crossover at these three rates.

The 1000BASE-T complies with IEEE 802.3ab, and uses the cable of 100-ohm Category-5 or Supper Category-5 UTP or STP, which can be up to 100 m.

The 1000BASE-T port uses four pairs of wires for transmission, all of which must be connected. Figure A-1 shows the connections of the twisted pairs used by the 1000BASE-T port.

Figure A-1 Schematic Diagram for the Four Twisted Pairs of the 1000BASE-T

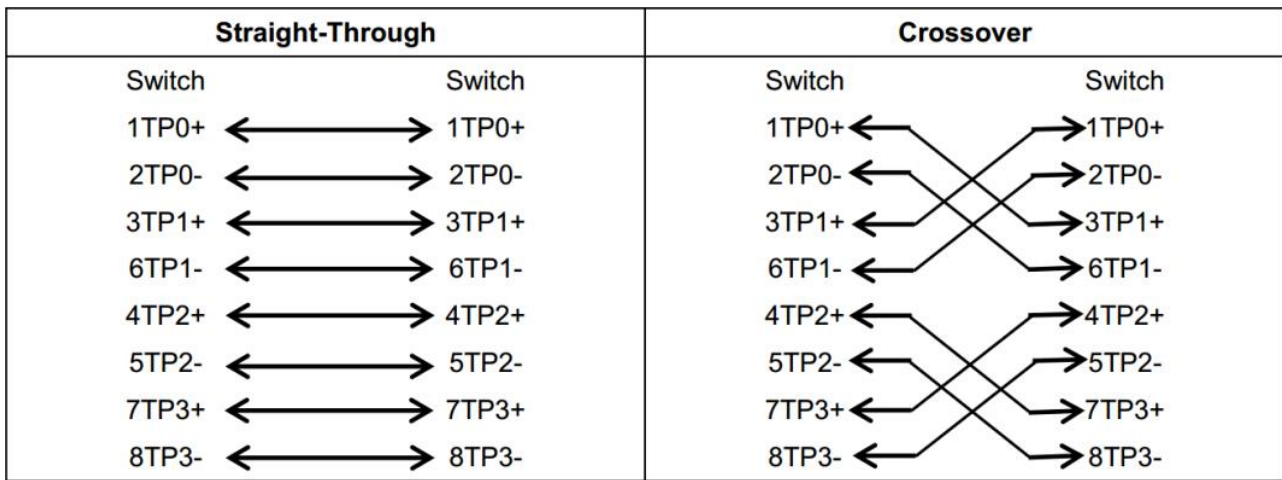

In addition to the above cables, the 100BASE-TX/10BASE-T can also use 100-ohm Category-3, 4, 5 cables for 10 Mbps, and 100-ohm Category-5 cables for 100 Mbps, both of which can be up to 100 m. 0 shows the pinouts of the 100BASE-TX/10BASE-T.

Figure A-2 Pinouts of the 100BASE-TX/10BASE-T

Pin	Socket	Plug
1	Input Receive Data+	Output Transmit Data+
2	Input Receive Data-	Output Transmit Data-
3	Output Transmit Data+	Input Receive Data+
6	Output Transmit Data-	Input Receive Data-
4,5,7,8	Not used	Not used

Figure A-3 shows the straight-through and crossover cable connections for the 100BASE-TX/10BASE-T.

Figure A-3 Connections of the Twisted Pairs of the 100BASE-TX/10BASE-T

Straight-Through		Crossover	
Switch	Adapter	Switch	Switch
1 IRD+	1 OTD+	1 IRD+	1 IRD+
2 IRD-	2 OTD-	2 IRD-	2 IRD-
3 OTD+	3 IRD+	3 OTD+	3 OTD+
6 OTD-	6 IRD-	6 OTD-	6 OTD-

Optical Fiber Connection

For the optical fiber ports, select single-mode or multiple-mode optical fibers for connection according to the fiber module connected. The connection schematic diagram is shown in Figure A-4:

Figure A-4 Schematic Diagram for optical fiber connection

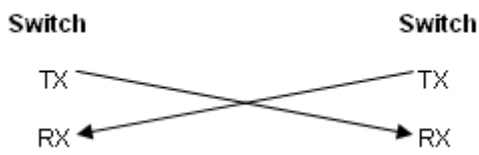

Appendix B Mini-GBIC, 10G SFP+ and 40G QSFP+ Modules Specifications

Ruijie Networks provides various Gigabit SFP (Mini-GBIC modules), and 10G SFP transceivers for interfaces of modules on the switch. You can select the most suitable SFP transceivers as needed. This appendix describes the models and specifications of some of the Gigabit and 10G SFP transceivers for your reference.

100M Mini-GBIC (SFP) Models and Specifications

Table B-1 Existing 100M Mini-GBIC (SFP) Models Supported

Model	Wavelength (nm)	Fiber type	DDM (Yes/No)	Transmit (dBm)		Receive (dBm)	
				Min	Max	Min	Max
FE-SFP-LX-MM1310	1310	MMF	Yes	-22	-14	-30	-14
FE-SFP-LH15-SM1310	1310	SMF	Yes	-15	-8	-28	-8
FE-SFP-LX20-SM1310-BIDI	1310TX/1550 RX	SMF	Yes	-15	-7	-28	-8
FE-SFP-LX20-SM1550-BIDI	1550TX/1310 RX	SMF	Yes	-15	-7	-28	-8
FE-SFP-LH40-SM1310-BIDI	1310TX/1550 RX	SMF	Yes	-7	-2	-32	-8
FE-SFP-LH40-SM1550-BIDI	1550TX/1310 RX	SMF	Yes	-7	-2	-32	-8
FE-eSFP-LH15-SM1310	1310	SMF	Yes	-15	-8	-28	-8

Table B-1 (continued)

Model	Interface Type	Fiber Type	Core Size (μm)	Cabling Distance
FE-SFP-LX-MM1310	LC	MMF	62.5/125	2 km
FE-SFP-LH15-SM1310	LC	SMF	9/125	15 km
FE-SFP-LX20-SM1310-BIDI	LC	SMF	9/125	20 km
FE-SFP-LX20-SM1550-BIDI	LC	SMF	9/125	20 km
FE-SFP-LH40-SM1310-BIDI	LC	SMF	9/125	40 km
FE-SFP-LH40-SM1550-BIDI	LC	SMF	9/125	40 km
FE-eSFP-LH15-SM1310	LC	SMF	9/125	15 km

¹ MMF=Multi-mode fiber

² SMF=Single-mode fiber

GE Mini-GBIC (SFP) Models and Specifications

Table B-2 Existing GE Mini-GBIC (SFP) Models Supported

Model	Wavelength (nm)	Fiber type	DDM (Yes/No)	Transmit (dBm)		Receive (dBm)	
				Min	Max	Min	Max
MINI-GBIC-SX-MM850	850	MMF	No	-9.5	-3	-17	0
MINI-GBIC-LX-SM1310	1310	SMF	No	-9.5	-3	-20	-3

GE-eSFP-SX-MM850	1310	MMF	No	-9.5	-3	-17	0
GE-eSFP-LX-SM1310	1310	SMF	Yes	-9.5	-3	-20	-3
GE-SFP-LX-SM1310	1310	SMF	No	-9.5	-3	-20	-3
MINI-GBIC-LH40-SM1310	1310	SMF	Yes	-2	3	-22	-3
GE-SFP-LX20-SM1310-BIDI	1310TX/1550RX	SMF	Yes	-9	-3	-20	-3
GE-SFP-LX20-SM1550-BIDI	1550TX/1310RX	SMF	Yes	-9	-3	-20	-3
GE-SFP-LH40-SM1310-BIDI	1310TX/1550RX	SMF	Yes	-5	0	-24	-1
GE-SFP-LH40-SM1550-BIDI	1550TX/1310RX	SMF	Yes	-5	0	-24	-1
MINI-GBIC-ZX50-SM1550	1550	SMF	Yes	-5	0	-22	-3
MINI-GBIC-ZX80-SM1550	1550	SMF	Yes	0	4.7	-22	-3
MINI-GBIC-ZX100-SM1550	1550	SMF	Yes	0	5	-30	-9
GE-SFP-SX	850	MMF	No	-9.5	-3	-17	0
GE-SFP-LX	1310	SMF	No	-9.5	-3	-20	-3

 When short-distant SMF modules are used based on the intensity of received lights, it is recommended to add optical attenuators to the connection to avoid damage including: FE-SFP-LX20-SM1310-BIDI, FE-SFP-LX20-SM1550-BIDI, FE-SFP-LH40-SM1310-BIDI, FE-SFP-LH40-SM1550-BIDI, GE-SFP-LH40-SM1310-BIDI, GE-SFP-LH40-SM1550-BIDI, MINI-GBIC-LH40-SM1310, MINI-GBIC-ZX50-SM1550, MINI-GBIC-ZX80-SM1550, MINI-GBIC-ZX100-SM1550, SDH155-SFP-LH40-SM1310 and SDH155-SFP-LH80-SM1550.

 The optical module is a laser device. Please take care of your eyes and do not look into the laser beam directly.

 To keep the optical module clean, please make sure that the dust cap is mounted when it is not connected to cables.

Table B-2 (continued)

Model	Interface Type	Fiber Type	Core Size (µm)	Cabling Distance
MINI-GBIC-SX-MM850	LC	MMF	62.5/125	275 m
			50/125	550 m
MINI-GBIC-LX-SM1310	LC	SMF	9/125	10 km
GE-eSFP-SX-MM850	LC	MMF	62.5/125	275 m
			50/125	550 m
GE-eSFP-LX-SM1310	LC	SMF	9/125	10 km
GE-SFP-LX-SM1310	LC	SMF	9/125	10 km
MINI-GBIC-LH40-SM1310	LC	SMF	9/125	40 km
GE-SFP-LX20-SM1310-BIDI	LC	SMF	9/125	20 km
GE-SFP-LX20-SM1550-BIDI	LC	SMF	9/125	20 km
GE-SFP-LH40-SM1310-BIDI	LC	SMF	9/125	40 km
GE-SFP-LH40-SM1550-BIDI	LC	SMF	9/125	40 km
MINI-GBIC-ZX50-SM1550	LC	SMF	9/125	50 km
MINI-GBIC-ZX80-SM1550	LC	SMF	9/125	80 km
MINI-GBIC-ZX100-SM1550	LC	SMF	9/125	100 km
GE-SFP-SX	LC	MMF	62.5/125	275 m
			50/125	550 m
GE-SFP-LX	LC	SMF	9/125	10 km

SFP BIDI Module Pairs

Table B-3 SFP BIDI Module Pair

Bandwidth/Distance	Pairs
100 M/20 km	FE-SFP-LX20-SM1310-BIDI FE-SFP-LX20-SM1550-BIDI
100 M/40 km	FE-SFP-LH40-SM1310-BIDI FE-SFP-LH40-SM1550-BIDI
GE/20 km	GE-SFP-LX20-SM1310-BIDI GE-SFP-LX20-SM1550-BIDI
GE/40 km	GE-SFP-LH40-SM1310-BIDI GE-SFP-LH40-SM1550-BIDI

 SFP BIDI modules should be used in pairs. For example, if a FE-SFP-LX20-SM1310-BIDI module is used on one end, apply FE-SFP-LX20-SM1550-BIDI on the other end.

Mini-GBIC-GT Models and Specifications

Table B-4 Existing Mini-GBIC-GT models supported:

Standard	Model
1000Base-T	Mini-GBIC-GT

Table B-4 (continued)

1000baseT	Cable Type	Cabling Distance	DDM (Yes/No)
Mini-GBIC-GT	Catogary-5 or above UTP/STP	100 m	No

10G SFP+ Models and Specifications

Table B-5 Existing 10G SFP+ models supported:

Model	Wavelength (nm)	DDM (Yes/No)	Fiber Type	Transmit (dBm)		Receive (dBm)	
				Min	Max	Min	Max
XG-SFP-SR-MM850	850	Yes	MMF	-5	-1	-7.5	0.5
XG-SFP-LR-SM1310	1310	Yes	SMF	-8.2	0.5	-10.3	0.5
XG-SFP-ER-SM1550	1550	Yes	SMF	-4.7	4	-11.3	-1
XG-SFP-ZR-SM1550	1550	Yes	SMF	0	4	-24	-7
XS-SFP-SR	850	Yes	MMF	-5	-1	-7.5	0.5
XS-SFP-LR	1310	Yes	SMF	-8.2	0.5	-10.3	0.5

 For XG-SFP-ER-SM1550 and XG-SFP-ZR-SM1550, do not use short-distant fibers in case of transceiver overload. If the light power received equals or exceeds -1dBm, add the optical attenuators to adjust the power as less than -1dBm.

Table B-5 (continued)

Model	Interface Type	Fiber Type	Core Size (µm)	Modal Bandwidth (MHz*km)	Max Cabling Distance
XG-SFP-SR-MM850	LC	MMF	62.5 /125	200 (OM1)	33 m
				160	26 m
			50/125	2000 (OM3)	300 m

				500 (OM2) 400 (OM1)	82 m 66 m
XG-SFP-LR-SM1310	LC	SMF	9/125	N/A	10 km
XG-SFP-ER-SM1550	LC	SMF	9/125	N/A	40 km
XG-SFP-ZR-SM1550	LC	SMF	9/125	N/A	80 km
XS-SFP-SR	LC	MMF	62.5 /125	200 (OM1) 160	33 m 26m
			50/125	2000 (OM3) 500 (OM2) 400 (OM1)	300 m 82 m 66 m
XS-SFP-LR	LC	SMF	9/125	N/A	10 km

Existing SFP+ copper cable models supported:

Model	Model Type	Connector Type	Copper Length (m)	AWG	Data Rate (Gb/s)	DDM (Yes/No)
XG-SFP-CU1M	Passive	SFP+	1	28	10.3125	No
XG-SFP-CU3M	Passive	SFP+	3	28	10.3125	No
XG-SFP-CU5M	Passive	SFP+	5	26	10.3125	No

i For supported SFP+ models may change at any time, contact Ruijie Networks after-sales personnel for the latest information.

i SFP+ copper cables can be inserted to ports directly without the help of other cables.

40G QSFP+ Models and Specifications

Table B-6 Existing 40G QSFP+ models supported:

Model	Wavelength (nm)	Interface Type	Fiber Type	DDM (Yes/No)	Transmit (dBm)		Receive (dBm)	
					Min	Max	Min	Max
40G-QSFP-SR-MM850	(840 ,860)	MPO	MMF	Yes	-7.6	2.4	-9.5	2.4
40G-QSFP-LSR-MM850	(840 ,860)	MPO	MMF	Yes	-7.5	1.0	-9.9	2.4
40G-QSFP-LR4-SM1310	(1264.5,1277.5) (1284.5,1297.5) (1304.5,1317.5) (1324.5,1337.5)	LC	SMF	Yes	-7.0	2.3	13.7	2.3
40G-QSFP-LR4-PSM-SM1310	(1260,1355)	MPO/APC	SMF	Yes	-6.2	0.5	-14.4	2.3

Table B-6 (continued)

Model	Wavelength (nm)	Interface Type	Fiber Type	Core Size (um)	Modal Bandwidth (MHz*km)	Cabling Distance
40G-QSFP-SR-MM850	(840 ,860)	MPO	MMF	50	2000	100 m (OM3)
				50	4700	150 m (OM4)
40G-QSFP-LSR-MM850	(840 ,860)	MPO	MMF	50	2000	300 m

						(OM3)
				50	4700	400 m (OM4)
40G-QSFP-LR4-SM1310	(1264.5,1277.5) (1284.5,1297.5) (1304.5,1317.5) (1324.5,1337.5)	LC	SMF	9	N/A	10 km
40G-QSFP-LR4-PSM-SM1310	(1260,1355)	MPO/APC	SMF	9	N/A	10 km

✔ 40G-QSFP-SR-MM850 DDM only supports temperature and voltage monitoring.

⚠ The optical module is a laser device. Please take care of your eyes and do not look into the laser beam directly.

⚠ To keep the optical module clean, please make sure that the dust cap is mounted when it is not connected to cables.

Existing 40G QSFP+ copper models supported:

Model	Model Type	Connector Type	Copper Length (m)	AWG	Data Rate (Gb/s)	DDM (Yes/No)
40G-QSFP-STA CK1M	Passive	QSFP+	1	28	4 lanes x 10.3125 (per lane) 4 lanes x 6.5625 (per lane)	No
40G-QSFP-STA CK3M	Passive	QSFP+	3	28	4 lanes x 10.3125 (per lane) 4 lanes x 6.5625 (per lane)	No

Appendix C Lightning Protection

Installing AC Power Arrester (lightning protection cable row)

The external lightning protection cable row shall be used on the AC power port to prevent the switch from being struck by lightning when the AC power cable is introduced from the outdoor and directly connected to the power port of the switch. The lightning protection cable row is fixed on the cabinet, operating table or the wall in the machine room using the line buttons and screws.

Figure C-1 Schematic Diagram for the Power Arrester

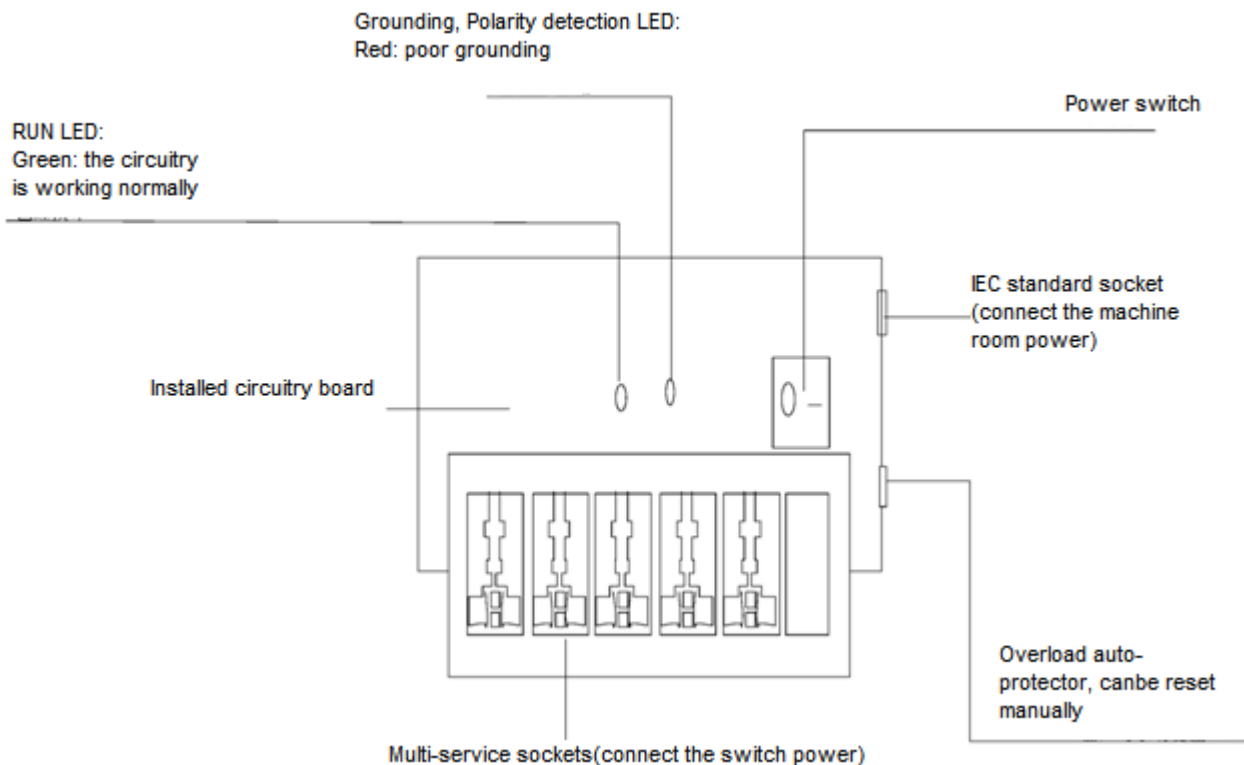

! The power arrester is not provided and the user shall purchase it to address the practical requirement.

Precautions for installation:

- Make sure that the PE terminal of the power arrester has been well-grounded;
- After connecting the switch AC power plug to the socket of the power arrester (lightning protection socket), lightning protection function implements if the RUN LED is Green and the ALARM LED is OFF.
- If the ALARM LED on the power arrester is Red, you shall check what the reason is, poor grounding connection or the reversed connection of the Null and Live lines: Use the multimeter to check the polarity of the power socket for the arrester when the LED is Red, if the N line is on the left and the L line is on the right, the arrester PE terminal is not grounded; if the L line is on the left and the N line is on the right, the polarity of the arrester power cable shall be reversed; if the LED is still Red, it is confirmed that the arrester PE terminal has not been grounded.

Installing the Ethernet Port Arrester

During the switch usage, the Ethernet port arrester shall be connected to the switch to prevent the switch damage by lightning before the outdoor network cable connects to the switch.

Tools: Cross or straight screwdriver, Multimeter, Diagonal pliers

Installation Steps:

- Tear one side of the protection paper for the double-sided adhesive tape and paste the tape to the framework of the Ethernet port arrester. Tear the other side of the protection paper for the double-sided adhesive tape and paste the Ethernet port arrester to the switch framework. The paste location for the Ethernet port arrester shall be as close to the grounding terminal of the switch.
- Based on the distance of the switch grounding terminal, cut the grounding line for the Ethernet port arrester and firmly tighten the grounding line to the grounding terminal of the switch.
- Use the multimeter to check whether the grounding line for the arrester is in good contact with the switch grounding terminal and the framework.
- According to the description on the Ethernet Port Arrester Hardware Installation Guide, connect the arrester using the adapter cable (note that the external network cable is connected to the end of IN, while the adapter cable connected to the switch is connected to the end of OUT) and observe whether the LED on the board is normal or not.
- Use the nylon button to bundle the power cables.

Figure C-2 Schematic Diagram for the Ethernet port Arrester Installation

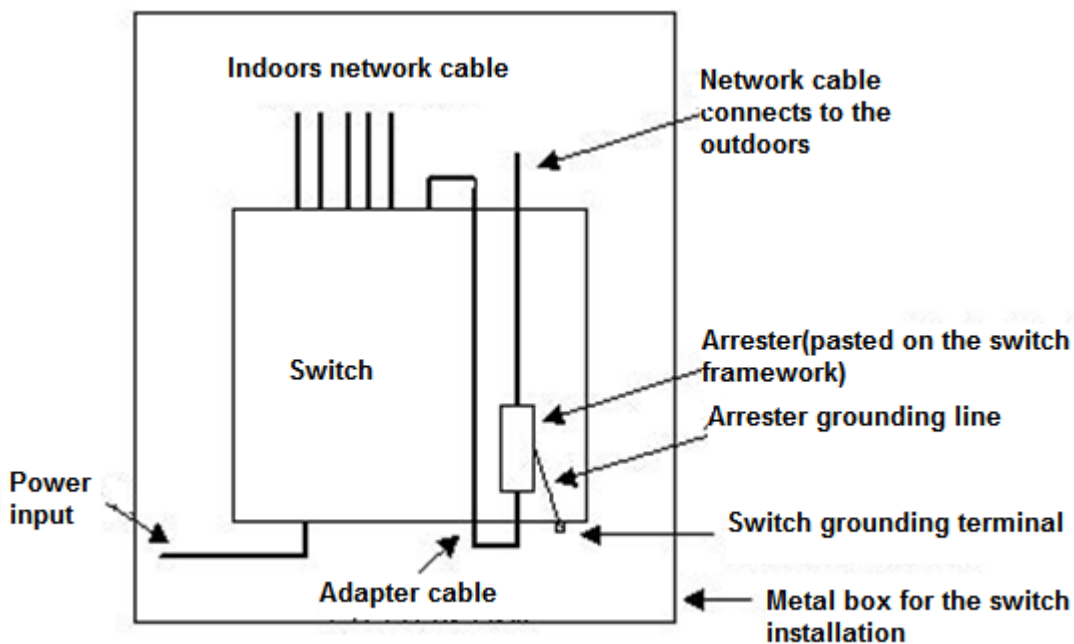

⚠ The Ethernet port arrester is only for the 10M/100M copper Ethernet ports with the RJ-45 connector;

⚠ The Ethernet port arrester is not provided, the user can purchase them to address their own practical requirements. For the detailed information during the arrester installation, please refer to Ethernet Port Arrester Hardware Installation Guide, which contains the technical specification and the maintenance and installation of the arrester.

You may pay attention to the following conditions during the actual installation to avoid influencing the performance of the Ethernet port arrester:

- Reversed direction of the arrester installation. You shall connect the external network cable to the “IN” end and connect the switch Ethernet port to the “OUT” end.
- Poor arrester grounding. The length of the grounding line should be as short as possible to ensure that it is in good contact with the switch grounding terminal. Use the multimeter to confirm the contact condition after the grounding.
- Incomplete arrester installation. If there is more than one port connected to the peer device on the switch, it needs to install the arresters on all connection ports for the purpose of the lightning protection.

Appendix D Cabling Recommendations

When RG-S5750H series switches are installed in standard 19-inch racks, route cable bundles upward or downward along the sides of the rack depends on the actual situation in the equipment room. All cable connectors should be placed at the bottom of the rack rather than be exposed outside of the cabinet. Power cords should be routed upward or downward beside the rack close to the location of the DC power distribution cabinet, AC power outlet, or lightning protection box.

Required Minimum Cable Bend Radius

- The minimum bend radius of a power, communication or flat cable should be 5 times the overall diameter of the cable. If the cable is constantly bent, plugged or unplugged, the bend radius should be 7 times the overall diameter.
- The minimum bend radius of a coaxial cable should be 7 times the overall diameter of the cable. If the cable is constantly bent, plugged or unplugged, the bend radius should be 10 times the overall diameter.
- The minimum bend radius of a high-speed cable, such as an SFP+ cable should be 5 times the overall diameter of the cable. If the cable is constantly bent, plugged or unplugged, the bend radius should be 10 times the overall diameter.

Required Minimum Fiber Bend Radius

- The diameter of a fiber tray to hold fibers cannot be less than 25 times the diameter of the fiber.
- When moving an optical fiber, the bend radius of the fiber should be equal to or greater than 20 times the diameter of the fiber.
- During cabling of an optical fiber, the bend radius of the fiber should be equal to or greater than 10 times the diameter of the fiber.

Precautions for Cable Bundling

- Before bundling cables, correctly mark labels and stick the labels to cables where appropriate.
- Cables should be neatly and properly bundled, as shown in Figure D-1.

Figure D-1 Bundling Cables

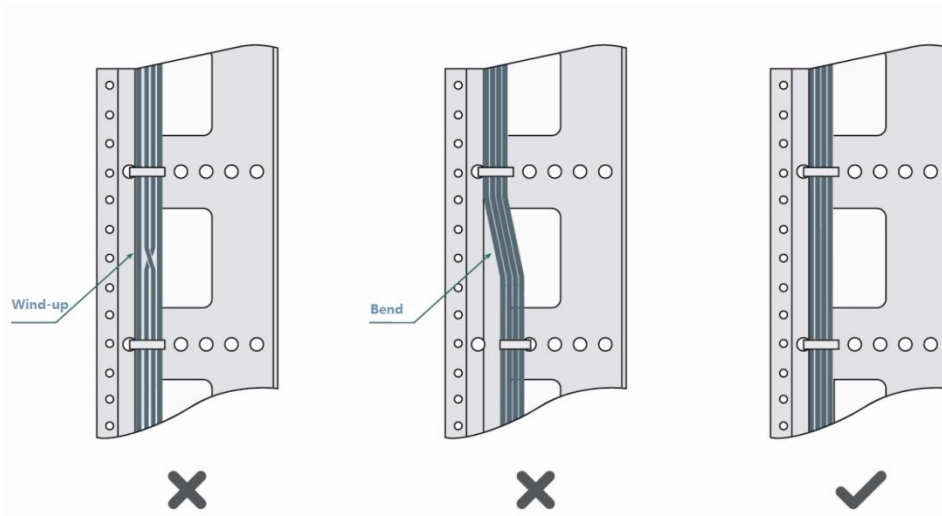

- Route and bundle power, signal, ground cables separately. When the cables are close to each other, cross them. When power cables run parallel to signal cables, the distance between them must b
- All cable trays and their accessories shall be smooth and free from sharp edges.
- Holes in metal, through which cables pass shall have smooth, well-rounded surfaces or be protected with insulating bushings.
- Use proper cable ties to bind cables together. Do not tie two or more cable ties to bind cables.
- Cut off excess cable tie cleanly with no sharp edges after bundling cables, as shown in Figure D-2.

Figure D-2 Cutting off Excess Cable Tie

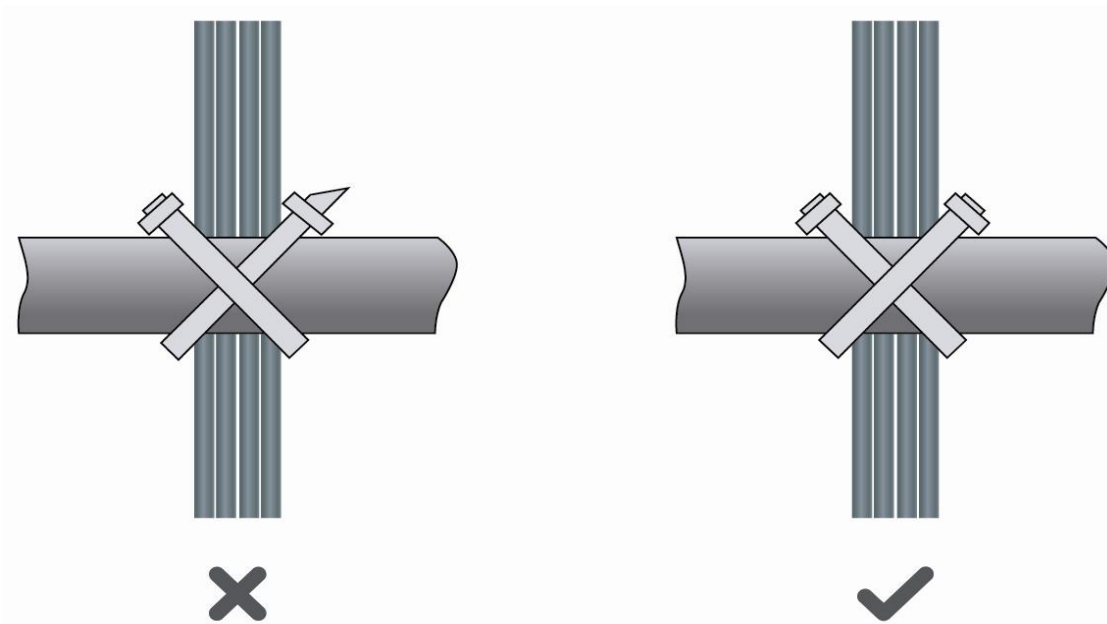

- If cables are to be bent, bind them first but do not tie cable ties within the bend to avoid stress on the cables, which may otherwise cause the wires inside to break, as shown in Figure D-3.

Figure D-3 Do Not Tie Cable Ties within the Bend

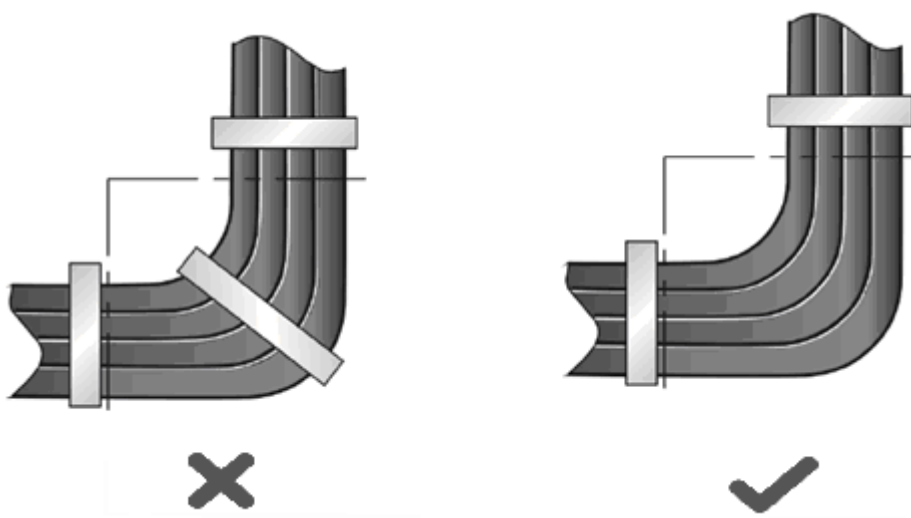

- Wrap up unnecessary or excess cables and bind them to the appropriate rack position, where device operation is not affected and no damages occur to the device and cables during debugging.
- Do not bind power cords to the rails for moving parts.

- Leave a certain length of the cable connecting moving parts, such as the ground wire of the cabinet door, to avoid stress on the cable; when moving parts are in place, ensure the excess cable length shall not contact heat sources, sharp corners or edges. If heat sources are unavoidable, use high-temperature cables instead.
- When using screws to fasten cable lugs, the bolts or nuts shall be tightened and prevented from loosening, as shown in Figure D-4.

Figure D-4 Fastening Cable Lugs

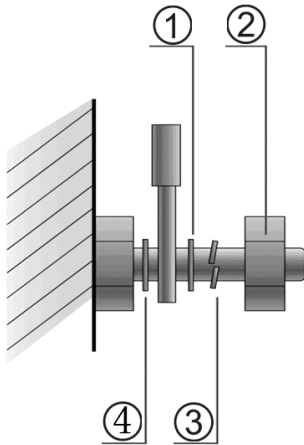

Note	Flat washer	Spring washer
	Nut	Flat washer

- When using a stiff cable, fix it near the cable lug to avoid stress on the lug and cable.
- Do not use self-tapping screws to fasten terminals.
- Bundle cables of the same type and running in the same direction into groups. Keep cables clean and straight.
- Cables shall be tied according to the following table.

Diameter of Cable Bundle (mm)	Space between Bundles (mm)
10	80 to 150
10 to 30	150 to 200
30	200 to 300

- Do not tie knots for cables or cable bundles.
- The metal parts of the cold-pressed terminal blocks, such as air circuit breakers, shall not be exposed outside of the blocks.

Appendix E Site Selection

- The machine room should be at least 5km away from the heavy pollution source such as the smelter, coal mine and thermal power plant, 3.7km away from the medium pollution source such as the chemical industry, rubber industry and electroplating industry, and 2km away from the light pollution source such as the food manufacturer and leather plant. If the pollution source is unavoidable, the machine room should be located on the windward side of the pollution source perennially with advanced protection.
- The machine room should be at least 3.7km away from the sea or salt lake. Otherwise, the machine room must be sealed, with air conditioner installed for temperature control. Saline soil cannot be used for construction. Otherwise, you should select devices with advanced protection against severe environment.
- Do not build the machine room in the proximity of livestock farms. Otherwise, the machine room should be located on the windward side of the pollution source perennially. The previous livestock house or fertilizer warehouse cannot be used as the machine room.
- The machine room should be firm enough to withstand severe weather conditions such as windstorm and heavy rain as well as away from dust. If the dust is unavoidable, keep the door and window away from the pollution source.
- The machine room should be away from the residential area. Otherwise, the machine room should meet the construction standard in terms of noise.
- Make sure the air vent of the machine room is away from the sewage pipe, septic tank, and sewage treatment tank. Keep the machine room under positive pressure to prevent corrosive gas from entering the machine room to corrode components and circuit boards. Keep the machine room away from industrial boiler and heating boiler.
- The machine room had better be on the second floor or above. Otherwise, the machine room floor should be 600mm higher than the highest flood level ever recorded.
- Make sure there are no cracks or holes in the wall and floor. If there are cable entries in the wall or window, take proper sealing measures. Ensure that the wall is flat, wear-resistant, and dust-free, which should be up to the standard for flame retarding, soundproofing, heat absorption, dust reduction, and electromagnetic shielding.
- Keep the door and the window closed to make the machine room sealed.
- The steel door is recommended for soundproofing.
- Sulfur-containing materials are forbidden.
- Pay attention to the location of the air conditioner. Keep the air conditioner from blowing wind straight toward the device or blowing water drops from the window or air vent toward the device.

Appendix F Mini USB Console Driver Installation

The Mini USB Console driver can be downloaded on the official TI website (<http://www.ti.com/>). The driver is now supported only on 32-bit Windows XP, 64-bit Windows XP, 32-bit Window Vista, 64-bit Window Vista, 32-bit Windows 7, and 64-bit Windows 7.

Installation Steps

Step 1: Double click the **Setup** file and choose **Next**.

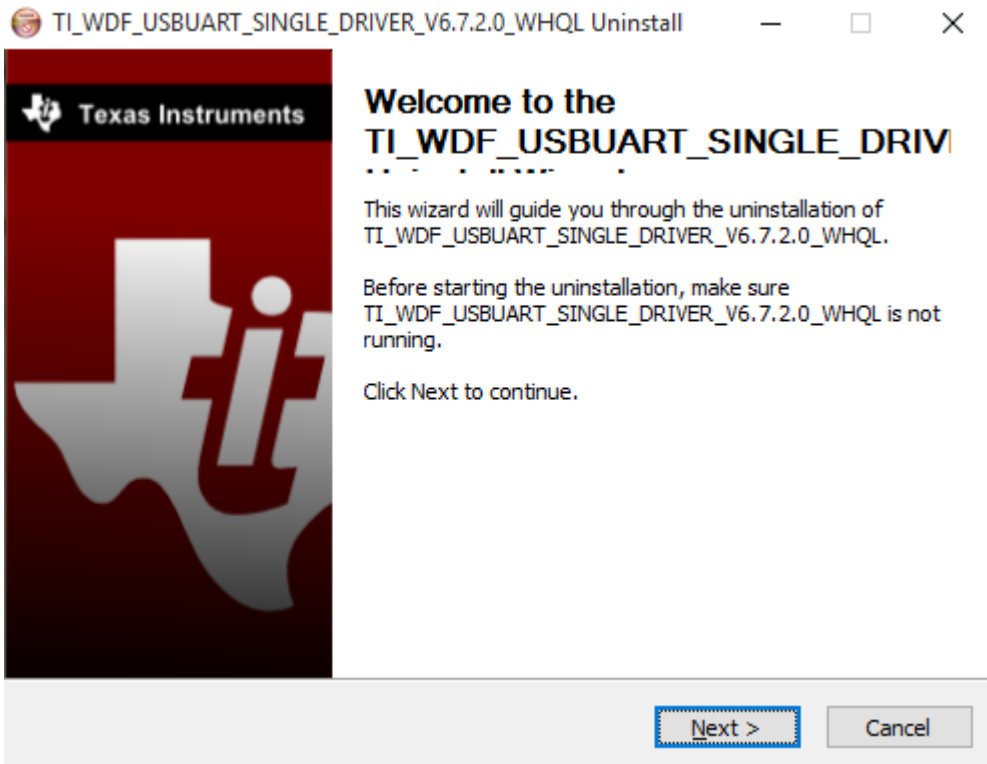

Step 2: Accept the **License Agreement** and click **Next**.

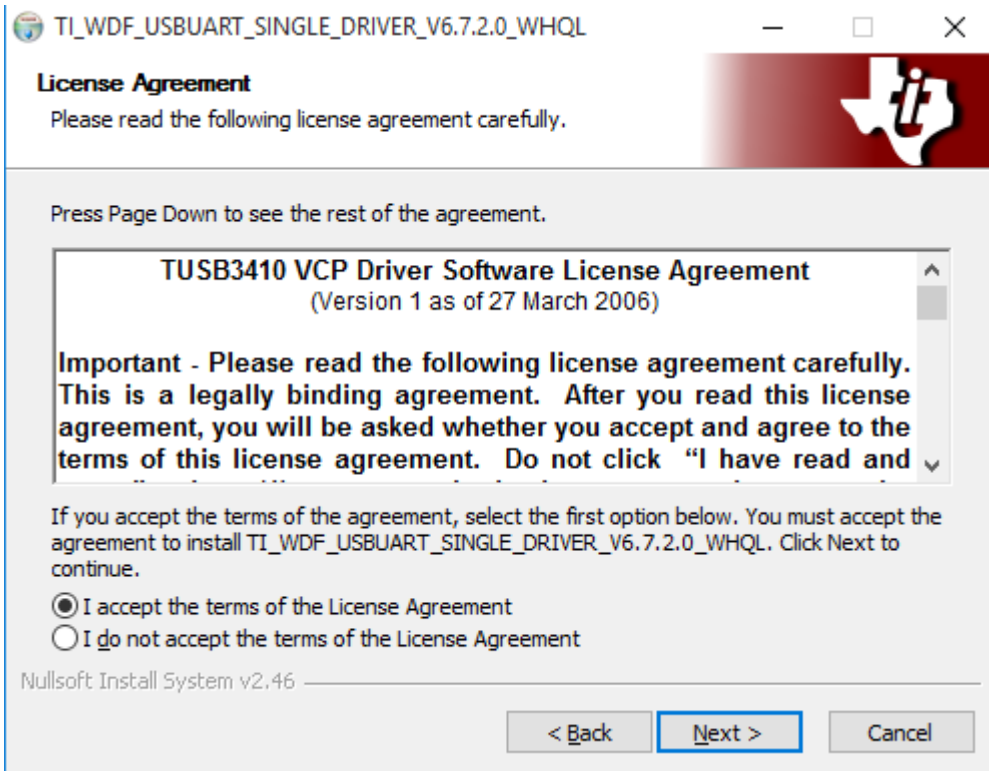

Step 3: Select the unpackage directory and click **Install**.

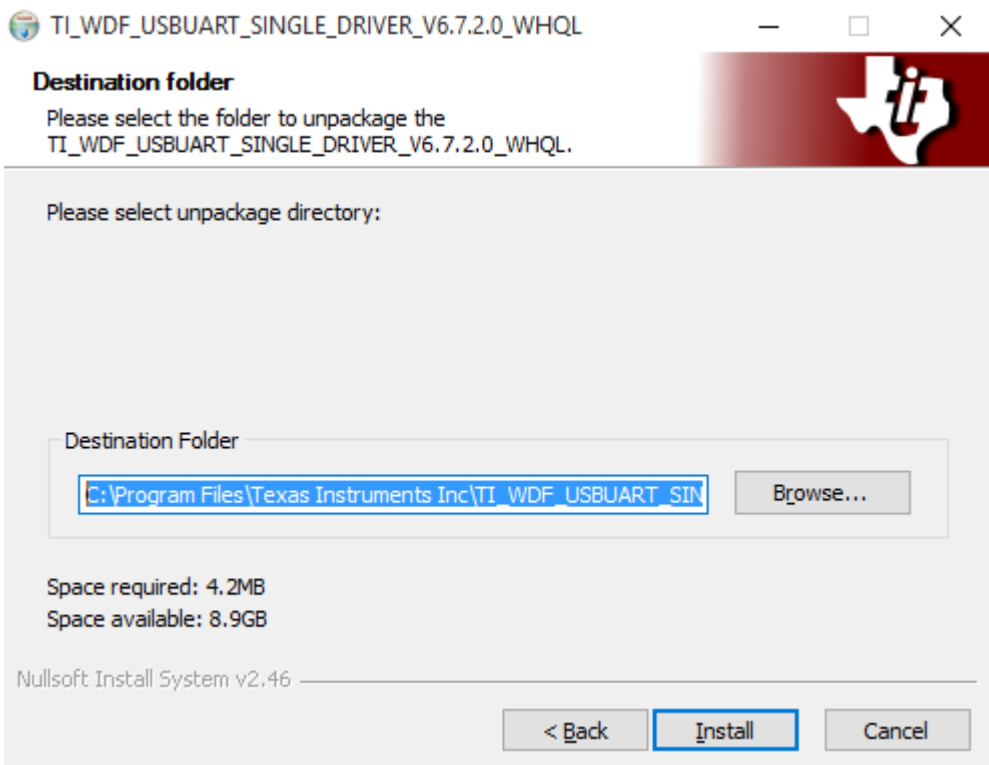

Step 4: After the driver is installed, click **Finish**.

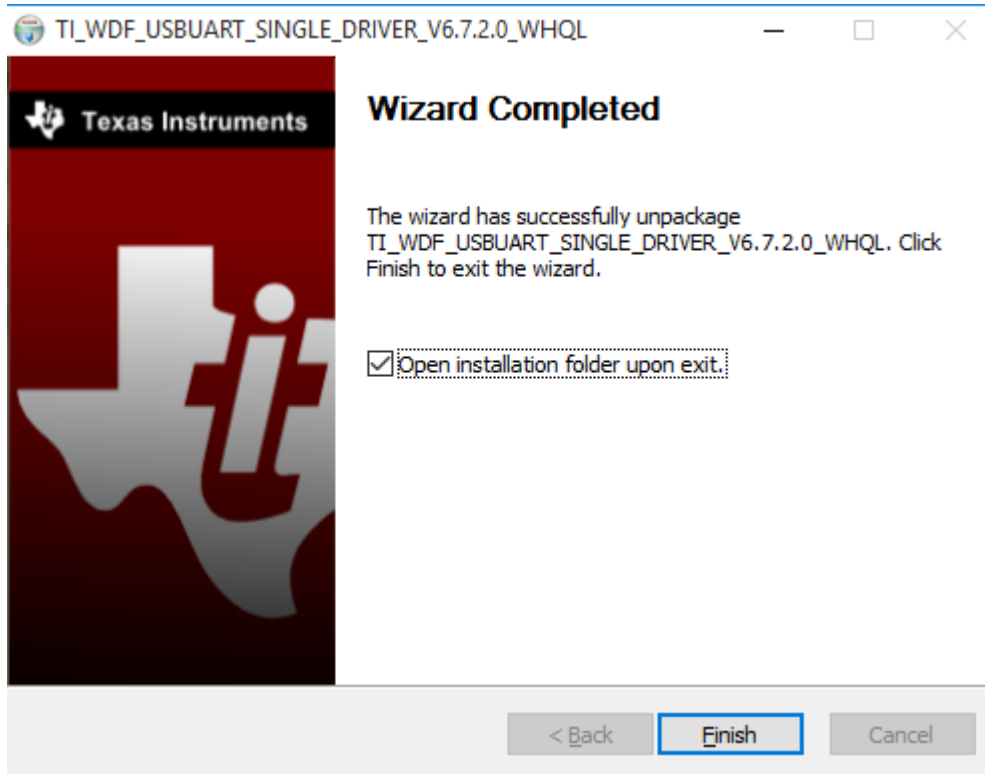

- After the Mini USB Console driver is installed, you are able to perform commissioning on devices with Mini USB ports using Type-A male USB to male Mini USB cables.

- ⓘ Right click Computer, choose Manage-Device Manager-Ports (COM & LPT), you will see the TUSB3410 Device. Change the serial port number to the port number of TUSB3410 Device, and then perform system commissioning. If you cannot find TUSB3410 Device there, re-install it or change the Type-A USB to Mini USB cables.